



POWERGOOD

Industry
Power Solution Expert



AC/DC Power Modules, DC/DC Power Modules

The Role of POWERGOOD in Industrial Automation

Provide Complete Standard Products

POWERGOOD provides AC/DC and DC/DC power modules for a variety of industrial automation equipment systems, with power from 1W to 600W, covering a variety of industrial standard sizes, so that customers can buy enough in one stop.

The input voltage range of 2:1 / 4:1 / 8:1 and 12:1 can fully meet various application scenarios, and greatly reduce the trouble of customer preparation through the wide input voltage coverage.

Under the same product size package, we provide different output power. When customers update or upgrade equipment or system, they only need to replace the power module, and there is no need to rearrange the circuit board of the system, so that system engineers have more advantages and flexibility in design and application.

Provide fast customized power supply

POWERGOOD provides flexible modular power supply (PSU) and customized power supply services. After in-depth communication with customers, we understand their specifications, safety regulations, assembly and other requirements, and work with customers to customize power modules that fully meet their requirements.

**EVERY
WATT
MATTERS!**



POWERGOOD Develops Reliable Power Modules

POWERGOOD's Actual Case

- Industrial Robots
- Industrial computer screens
- Industrial camera equipment
- Radar motor control system
- Water quality measurement systems
- Data acquisition system
- Ground drone monitoring equipment
- Satellite communications equipment
- Network communication equipment
- 5G data test equipment
- IOT device applications
- POE equipment



Quality Certification

Quality Persistence

POWERGOOD does not sacrifice quality for the sake of cost. We adhere to the best quality and meet customer requirements. Our quality control system is in line with world standards.

Quality Consciousness

From R&D quality, manufacturing quality, personnel quality and environmental quality, we implement the spirit of Total Quality Management (TQM) through a sound education and training system.

Quality is our Brand

Pursue the highest customer satisfaction and reliability, with customers, POWERGOOD, suppliers to achieve the goal of three win. We uphold the "continuous improvement, no best, only better" philosophy, which makes safety and high reliability the brand value of POWERGOOD.



High Quality Shipment Inspection

POWERGOOD independently developed two systems (ATS and MES), the Automatic Test System (ATS) makes product testing more accurate and consistent; the Manufacturing Execution System (MES) enables real-time monitoring and recording of production process history, enabling product traceability.

"Quality First" makes "Customer satisfaction" is one of POWERGOOD's key indicators. All POWERGOOD products are 100% tested and have passed at least two tests (semi-finished products and finished products), as well as spot inspection and other rigorous checks to ensure product quality.

Sustainable Supply Chain Management

POWERGOOD has a complete set of perfect recognition standards for the adoption of components. Based on the results of supplier selection and audit, we develop improvement measures and assists suppliers to continuously improve supply chain management system, and establish sustainable growth partnership.

Green Product and Safety Certification

POWERGOOD products have passed and complied with international regulations and standards, such as UL /CUL /IEC /EN 62368-1, EN50155, EN45545-2, CE, RoHS, REACH, etc.

POWERGOOD designs, develops and manufactures friendly products that are non-toxic and extend the life of products under low temperature environment.

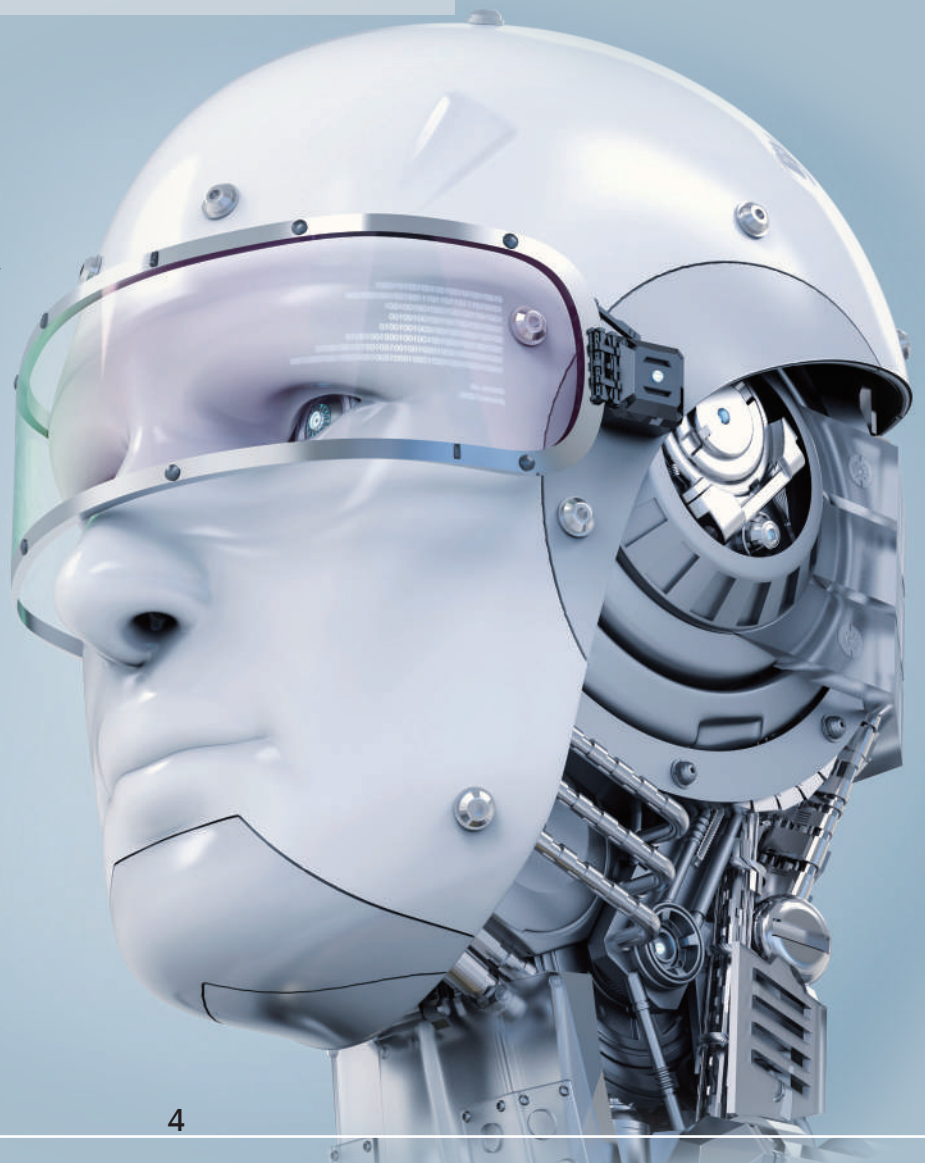

Product Advantage

High Power Density

POWERGOOD offers high power density ratio products with compact packages. POWERGOOD's AC/DC power modules offer power up to 700W, and with a power density of up to $181.82\text{W}/\text{In}^3$. We provide customers with a better cost structure and more option to meet customer needs to reduce total cost and all-key design, creating the best competitive advantage.

Wide Input Voltage

POWERGOOD's power supply modules offer a wide range of input voltages to choose from; In addition to 2:1 voltage, standard DC/DC products offer input voltage ranges of 4:1 voltage, 8:1 voltage, and even 12:1 voltage, and all of them cover different levels of output power. Our product also covers different levels of output voltages and EMI anti-interference capability. Its performance is superior to that of conventional industrial power supplies.



Product Advantage

Wide Operating Case Temperature

POWERGOOD's industrial solution offers an ultra-wide range of operating case temperatures. The operating case temperature of AC/DC power modules is up to $-40^{\circ}\text{C} \sim +100^{\circ}\text{C}$, and the operating case temperature of DC/DC power modules is up to $-40^{\circ}\text{C} \sim +115^{\circ}\text{C}$, can overcome the harsh requirements of the industrial environment.

Customized Power Solution

POWERGOOD has many years of R&D experience and professional technology, from the needs assessment, research and development design, safety certification to the delivery of the goods, with the most professional technology and high quality service, tailored belongs to the power of the customer solutions, and meet customer requirement in application.

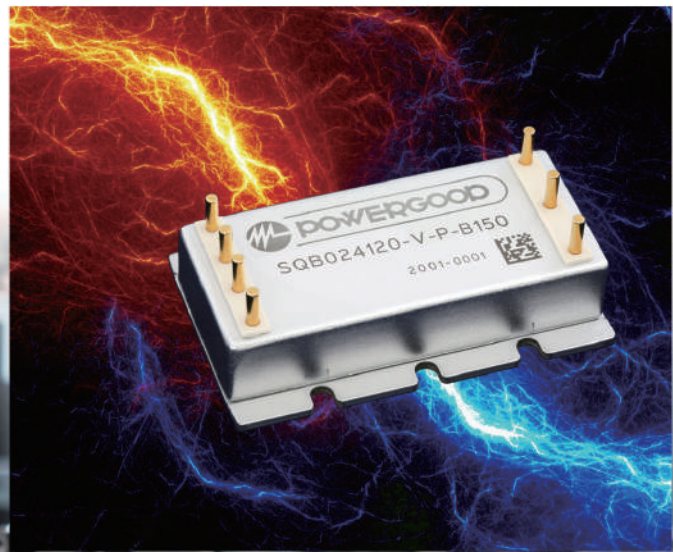

Industry Application Product Line

AC/DC power modules for POWERGOOD Industry Application

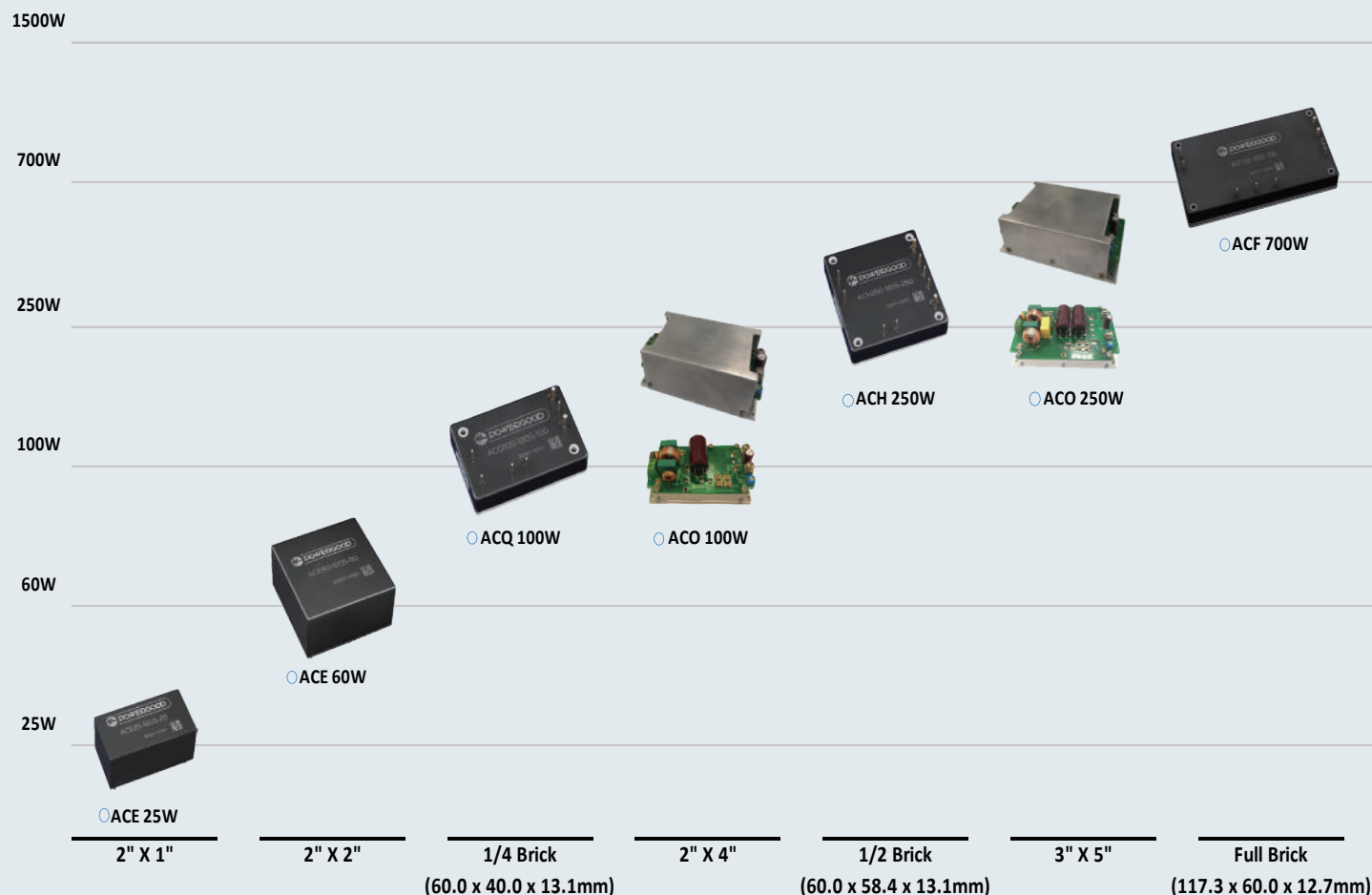

DC/DC Power Module for POWERGOOD Industrial Applications - Low Power Unregulated Series

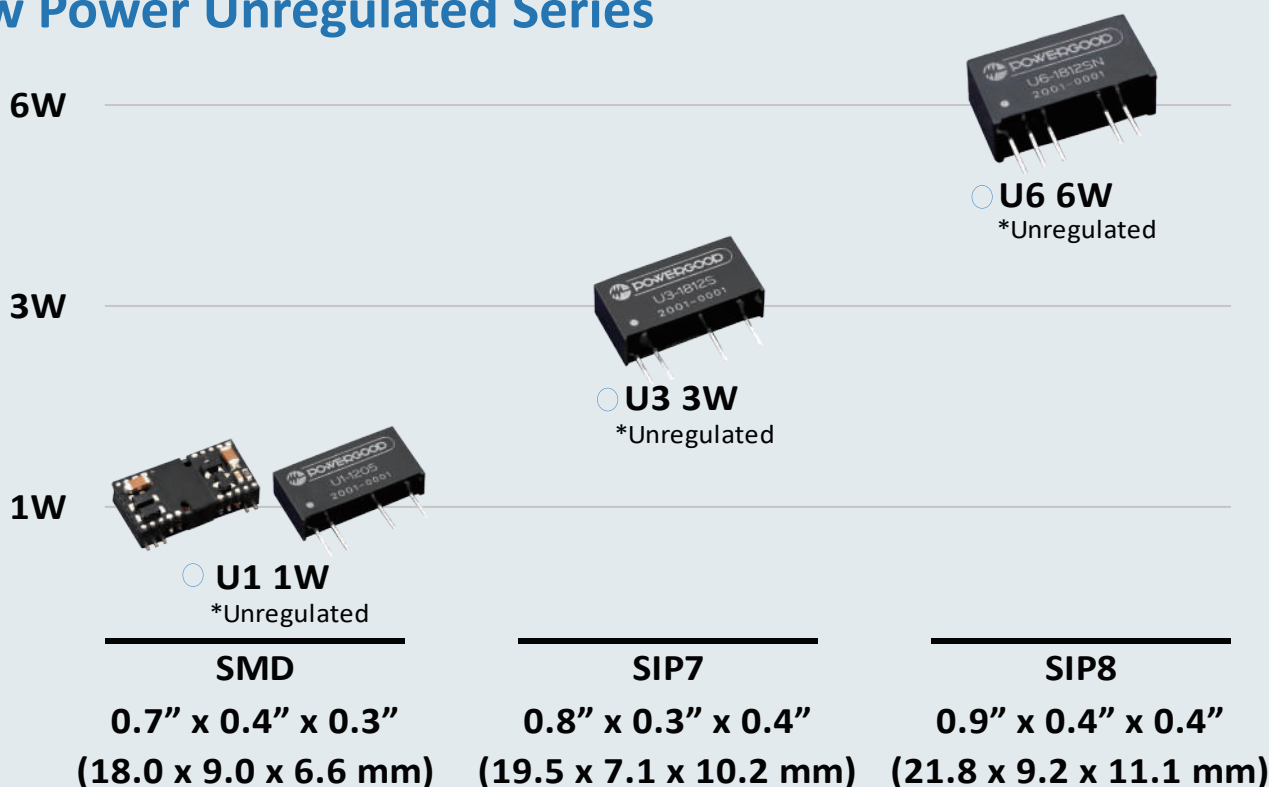

Industry Application Product Line

DC/DC Power Module for POWERGOOD Industrial Applications – Encapsulated Series

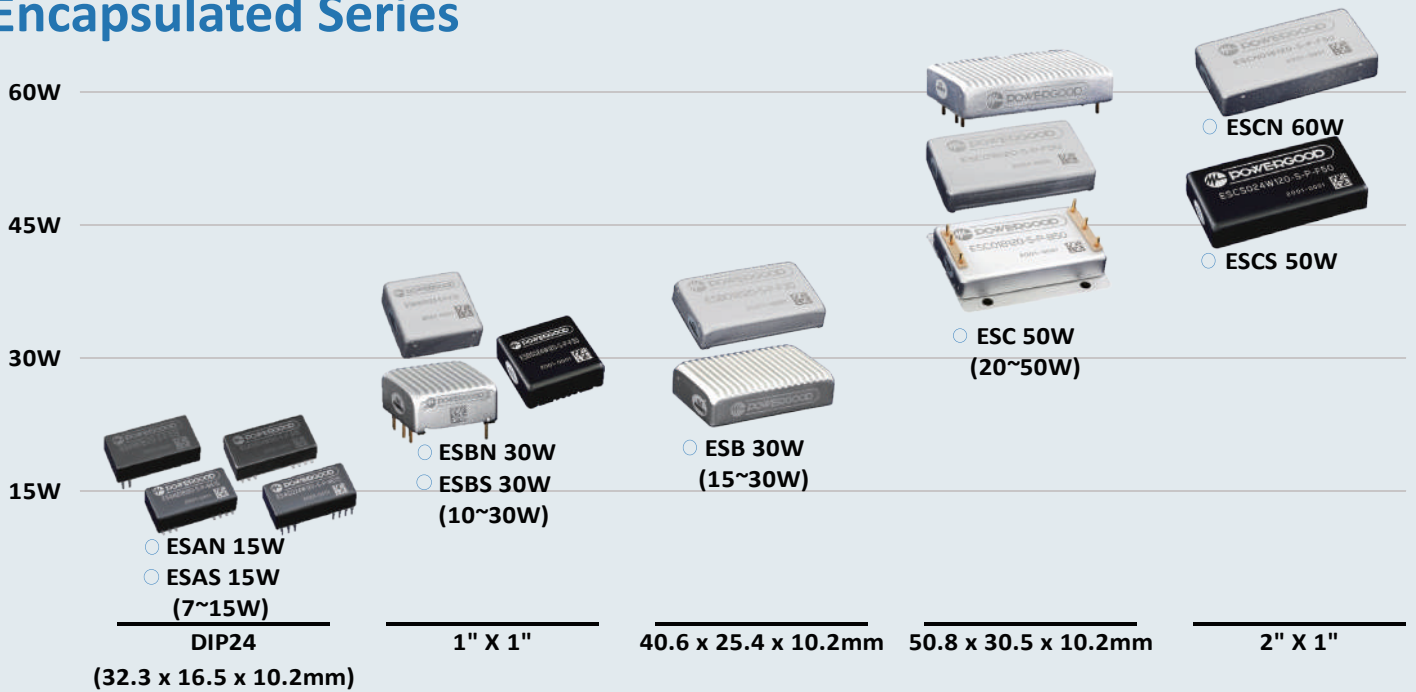

DC/DC Power Module for POWERGOOD Industrial Applications – Brick Series

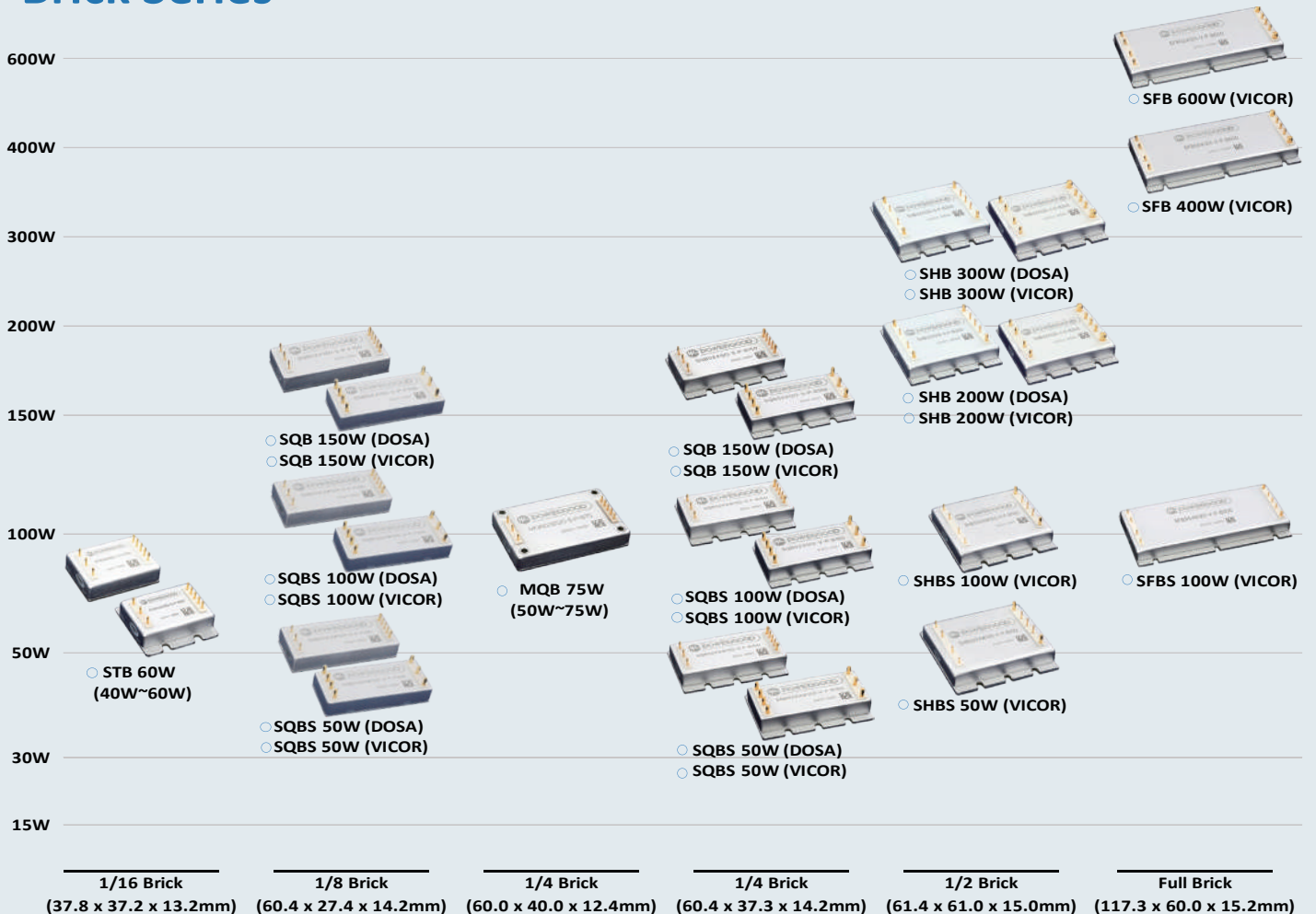

AC/DC Industry Application Product Introduction

AC/DC Encapsulated Series Product Feature

- Built in EMI filter meets EN55032 Class B without external components
- Maximum power density ratio
- Provides 2 times peak load capacity
- Isolation voltage up to 4000 VAC
- Easy Hold-up time extension
- Leakage current 100µA
- Output voltage trim range of -10%, +10%
- Fully protected: OCP / OVP / OTP / SCP
- Packaged for PCB plug-in
- Design conforms to the standard EN55032 & CIRSS/ FCC class B
- Design conforms to the standard IEC62368 EN62386 UL62368-1-1-1
- Design conforms to the standard iec60601-1 EN60601 UL60601-1-1
- Design conforms to the standard IEC60335 EN60335 UL60335-1-1-1

ACE25 Series

25W / 2" x 1"

Input Voltage: 90-264 VAC

Output Voltage:
5, 12, 15, 24, 36, 48 VDC

Output Power: 25W

Operating Case Temperature:
-40°C ~ 80°C

High Efficiency up to 88%

Package: Plastic Case

Size: 2.10" x 1.10" x 0.96"
53.4 x 28.0 x 24.4 mm

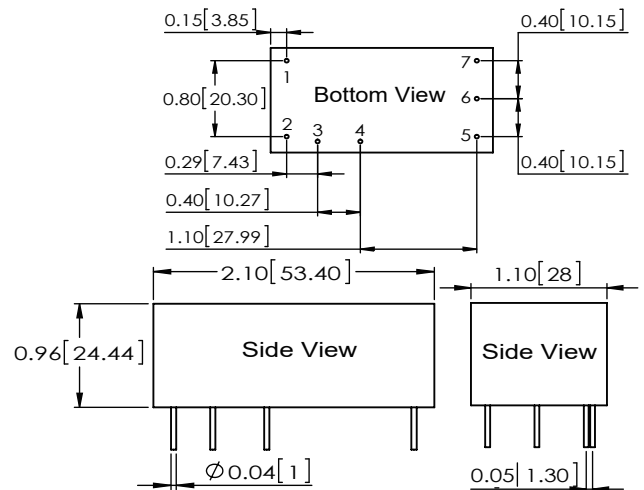

ACE60 Series

60W / 2" x 2"

Input Voltage: 90-264 VAC

Output Voltage:
5, 12, 15, 24, 36, 48 VDC

Output Power: 60W

Operating Case Temperature:
-40°C ~ 80°C

High Efficiency up to 90%

Package: Plastic Case

Size: 2.10" x 2.10" x 1.10"
53.3 x 53.3 x 27.9 mm

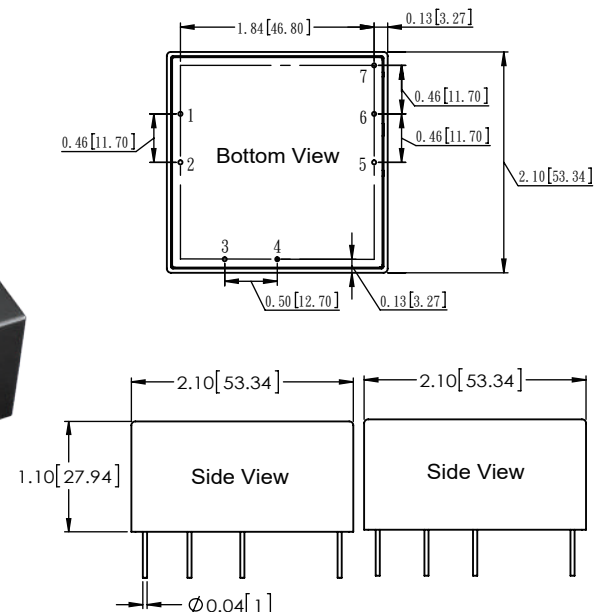

AC/DC Industry Application Product Introduction

AC/DC Brick Series Product Feature

- Ultra-thin design (0.5 inch) for brick type, with the world's largest power density ratio.
- No life-span constrained Ceramic Capacitor inside
- Built-in active power factor correction (PFC)
- Output voltage trim range of -5%, +5%
- Fully protected: OCP / OVP / OTP / SCP
- No aluminum and tantalum electrolytic capacitor inside for high reliability
- Isolation voltage up to 3000 VAC
- Conduction cooling (e.g. heat radiation from the aluminum base plate to the attached heat sink)

ACQ100 Series

100W / 1/4 Brick

Input Voltage: 90-264 VAC

Output Voltage: 5, 12, 24, 28, 36, 48 VDC

Output Power: 100W

Operating Case Temperature:

-40°C ~ 100°C

High Efficiency up to 91%

Package: Aluminum base with plastic case

Size: 2.36" x 1.57" x 0.50"
60.0 x 40.0 x 12.7mm

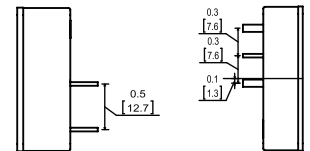
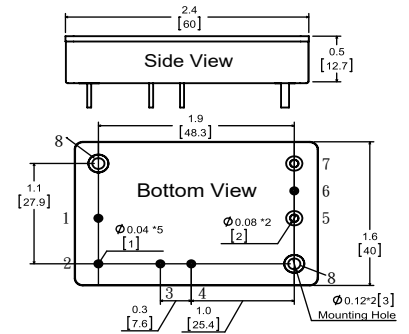

ACH250 Series

250W / 1/2 Brick

Input Voltage: 90-264 VAC

Output Voltage: 12, 24, 28, 36, 48 VDC

Output Power: 250W

Operating Case Temperature: :

-40°C ~ 100°C

High Efficiency up to 91%

Provide remote on/off function (optional)

Package: Aluminum base with plastic case

Size: 2.36" x 2.30" x 0.50"
60.0 x 58.4 x 12.7mm

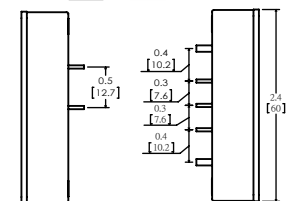
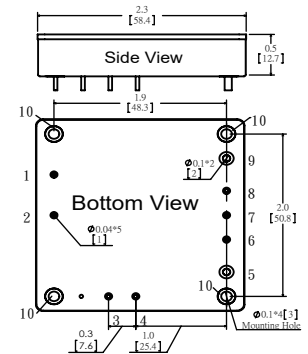

ACF700 Series

700W / Full Brick

Input Voltage: 90-264 VAC

Output Voltage: 12, 24, 28, 36, 48 VDC

Output Power: 700W

Operating Case Temperature:

-40°C ~ 100°C

High Efficiency up to 90%

Package: Aluminum base with plastic case

Provide parallel function

Size: 4.62" x 2.40" x 0.50"
117.3 x 60.0 x 12.7mm

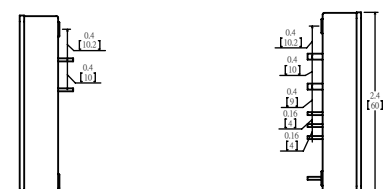
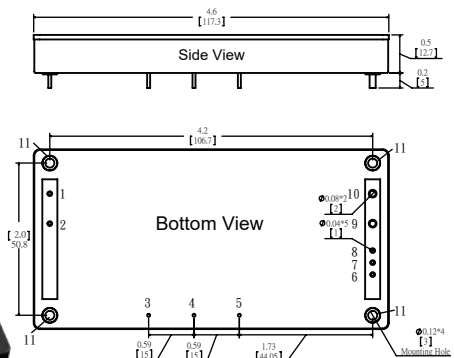

AC/DC Industry Application Product Introduction

AC/DC PSU Product Feature

- Built-in EMI filter meets EN55032 Class B without external components
- Built-in active power factor correction (PFC)
- Isolation voltage up to 3000 VAC
- Output voltage trim range of -5%, +5%
- Fully protected: OCP / OVP / OTP / SCP

- Conduction cooling (e.g. heat radiation from the aluminum base plate to the attached heat sink)
- Open Frame & Aluminum case is optional
- Built-in heat sink
- Terminal blocks for easy wiring and reliable operation

ACO100 Series

100W /PSU

Input Voltage: 90-264 VAC

Output Voltage: 5, 12, 24, 28, 36, 48 VDC

Output Power: 100W

Operating Case Temperature:

-40°C ~ 100°C

High Efficiency up to 91%

Package: Open Frame & Aluminum Case & Din Rail

Size: 4.00" x 2.06" x 1.57"
101.6 x 52.4 x 40.0 mm

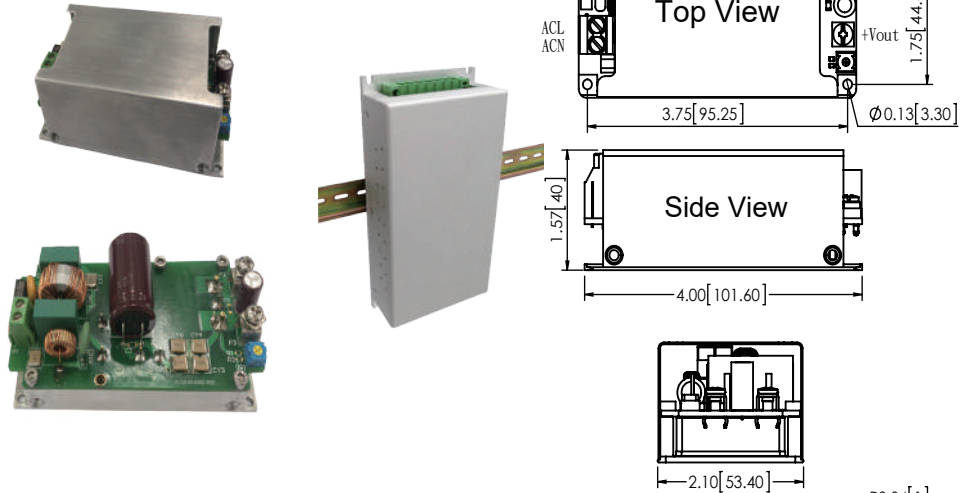

ACO250 Series

250W /PSU

Input Voltage: 90-264 VAC

Output Voltage: 12, 24, 28, 36, 48 VDC

Output Power: 250W

Operating Case Temperature:

-40°C ~ 100°C

High Efficiency up to 91%

Package: Open Frame & Aluminum Case & Din Rail

Size: 5.00" x 3.03" x 1.57"
127.0 x 77.0 x 40.0 mm

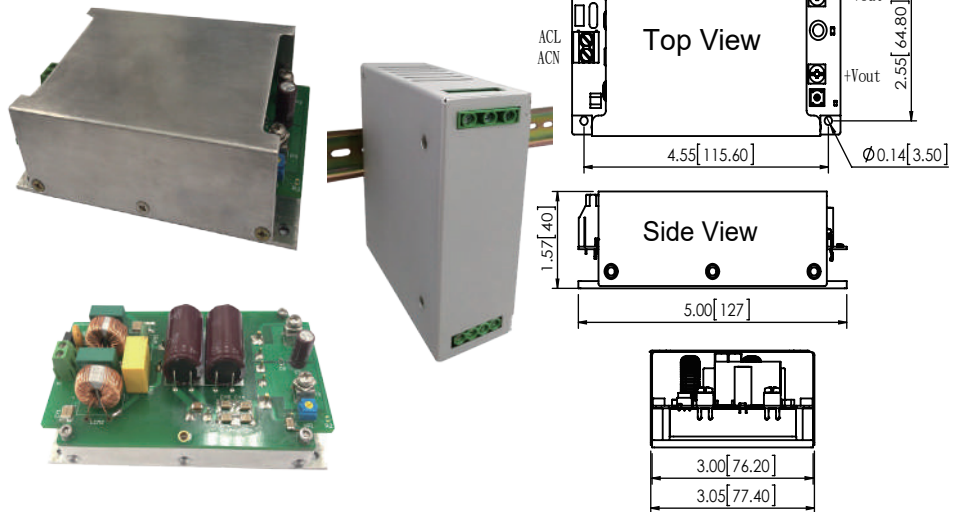

ACO700 Series

700W /PSU

Input Voltage: 90-264 VAC

Output Voltage: 12, 24, 28, 36, 48 VDC

Output Power: 700W

Operating Case Temperature:

-40°C ~ 100°C

High Efficiency up to 90%

Package: Open Frame & Aluminum Case & Din Rail

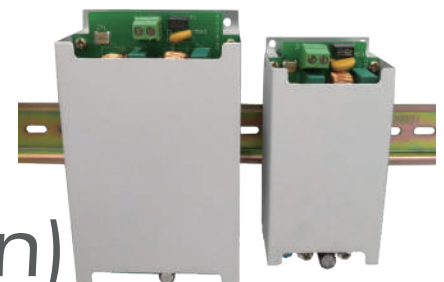

(Coming Soon)

DC/DC Industry Application Product Introduction

DC/DC U Series Product Feature

- Isolated regulated DC DC converter
- 40°C to +105°C operation without power derating (depending on model)
- Continuous short circuit protection
- Input to output isolation 3K ~ 4K VDC (depending on the model, 6K VDC is optional)
- Capacitive loads up to 2,200µF

U1 Series

1W / SMD · SIP7

Input Voltage:

4.5-5.5, 10.8-13.2, 21.6-26.4 VDC

Output Voltage: 5 VDC

Output Power: 1W

Operating Case Temperature:

-40°C ~ 105°C

High Efficiency up to 81%

Package: Plastic Case

Size: 0.71" x 0.35" x 0.30"

18.0 x 9.0 x 6.6 mm

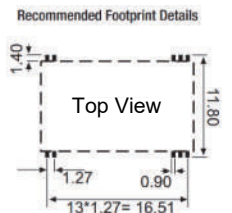
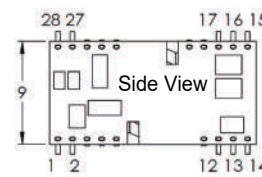
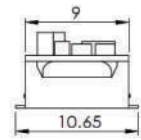
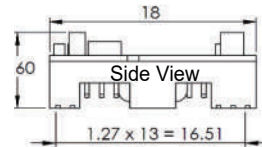

U3 Series

3W / SIP7

2:1 / 4:1 Wide Input Voltage:

4.5-5.5, 9-36, 18-75 VDC

Output Voltage: 5, 12, 24 VDC

Output Power: 3W

Operating Case Temperature:

-40°C ~ 85°C

High Efficiency up to 82%

Package: Plastic Case

Size: 0.77" x 0.28" x 0.40"

19.5 x 7.1 x 10.2 mm

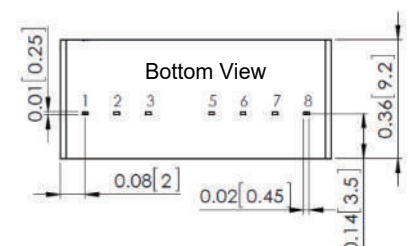
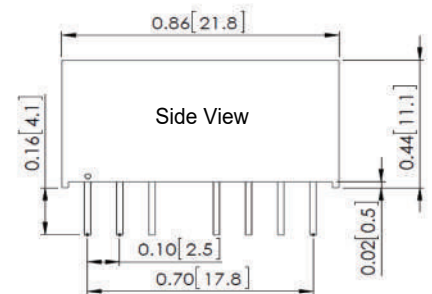
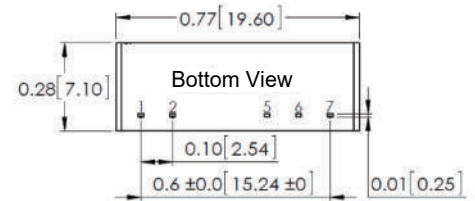
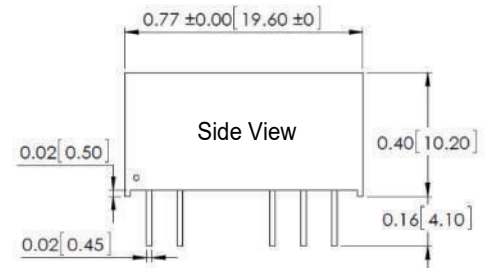

U6 Series

6W / SIP8

4:1 Wide Input Voltage:

9-36, 18-75 VDC

Output Voltage: 5, 12, 24 VDC

Output Power: 6W

Operating Case Temperature:

-40°C ~ 100°C

High Efficiency up to 85%

Package: Plastic Case

Size: 0.86" x 0.36" x 0.44"

21.8 x 9.2 x 11.1 mm

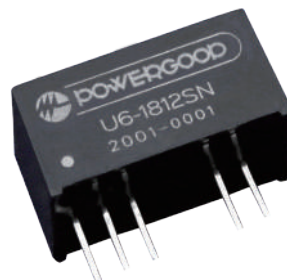

DC/DC Industry Application Product Introduction

DC/DC Encapsulated - E Product Feature

- Single / Dual Outputs
- Built-in EMI filter meets EN55032 Class B without external components
- Saving up to 20% of the circuit board space
- Wide Operating Temperature $-45^{\circ}\text{C} \sim +115^{\circ}\text{C}$ (Optional: $-55^{\circ}\text{C} \sim +125^{\circ}\text{C}$)

- Isolation voltage up to 2000 VDC
- No life-span constrained Ceramic Capacitor inside
- Industrial standard pins, metal shell design, easy to heat dissipation and EMI
- Output voltage trim range of -10% , $+10\%$
- Fully protected: OCP / OVP / OTP / SCP

ESB Series

15W~30W / 1.6" x 1"

2:1 / 4:1 Wide Input Voltage: 9-18, 9-36, 18-36, 18-75, 36-75 VDC

Output Voltage: 3.3, 5, 12, 15, 24, ± 5 , ± 12 , ± 15 , ± 24 VDC

Output Power: 15W ~ 30W

Operating Case Temperature:

$-45^{\circ}\text{C} \sim 115^{\circ}\text{C}$

High Efficiency up to 91%

Package: Flat & Heat sink embedded

Size: 1.60" x 1.00" x 0.40" (0.50")
40.6 x 25.4 x 10.2 (12.7)mm

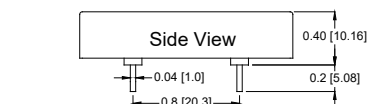

ESB Series Flat

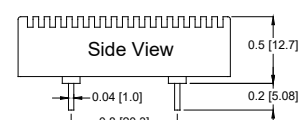

ESB Series Heat Sink Embedded

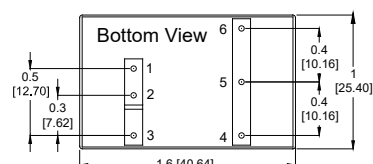

ESB Series Pinout

ESC Series

20W~50W / 2" x 1.2"

2:1 / 4:1 Wide Input Voltage: 9-18, 9-36, 18-36, 18-75, 36-75, 40-160 VDC

Output Voltage: 3.3, 5, 12, 15, 24, ± 12 , ± 15 , ± 24 VDC

Output Power: 20W ~ 50W

Operating Case Temperature:

$-45^{\circ}\text{C} \sim 115^{\circ}\text{C}$

High Efficiency up to 90%

Package: Flat & Heat sink embedded

Size: 2.00" x 1.20" x 0.40" (0.50")
50.8 x 30.5 x 10.2 (12.7) mm

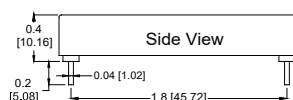

ESC Series Flat

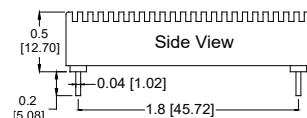

ESC Series Heat Sink Embedded

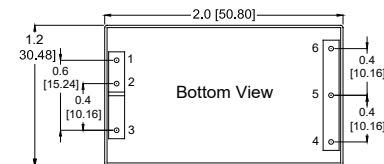

ESC Series Pinout

ESC Series

20W~50W / 2" x 1.6"

4:1 Wide Input Voltage: 9-18, 9-36, 18-36, 18-75, 36-75, 40-160 VDC

Output Voltage: 3.3, 5, 12, 15, 24, ± 12 , ± 15 , ± 24 VDC

Output Power: 20W ~ 50W

Operating Case Temperature:

$-45^{\circ}\text{C} \sim 115^{\circ}\text{C}$

High Efficiency up to 90%

Package: 6 sides aluminum case with flange

Size: 2.00" x 1.60" x 0.45"
50.8 x 40.6 x 11.4 mm

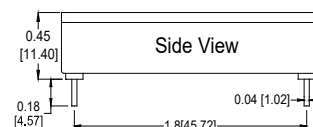

ESC Series Baseplate (with Flange)

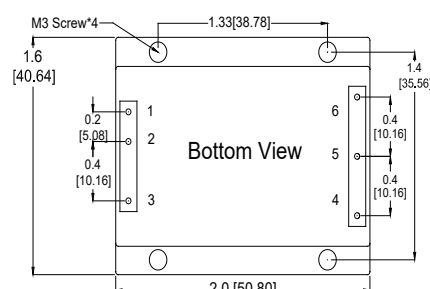

ESC Series Pinout

DC/DC Industry Application Product Introduction

DC/DC Encapsulated - N Product Feature

- Single / Dual Outputs
- Built-in EMI filter meets EN55032 Class A without external components (Depends on different model)
- Isolation voltage up to 2000 VDC
- No life-span constrained Ceramic Capacitor inside
- Industrial standard pins, metal shell design, easy to heat dissipation and EMI
- Maximum power density: up to 60 watts
- Provide remote control of output voltage
- Output voltage trim range of -10%, +10%
- Fully protected: OCP / OVP / OTP / UVLO

ESAN Series

7W~15W / DIP24 · SMD24

2:1 / 4:1 Wide Input Voltage: 9-36, 18-36, 18-75, 36-75, 40-160 VDC
 Output Voltage: 3.3, 5, 12, 15, ±5, ±12, ±15 VDC
 Output Power: 7W ~ 15W
 Operating Case Temperature: -45°C ~ 85°C
 High Efficiency up to 89%
 Package: Metal Case & Plastic Case
 Size: 1.27" x 0.65" x 0.40"
 32.3 x 16.5 x 10.2mm

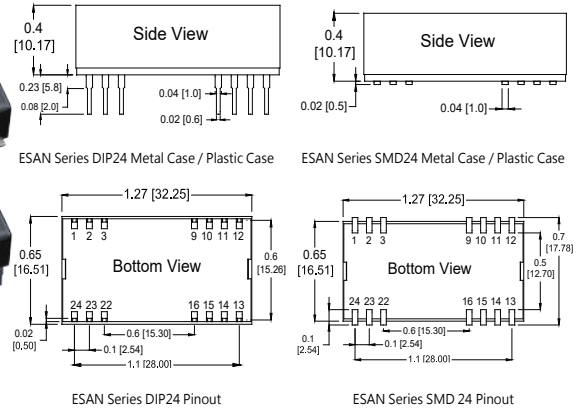

ESBN Series

10W~20W / 1" x 1"

2:1 / 4:1 Wide Input Voltage: 9-36, 18-36, 18-75, 36-75, 40-160 VDC
 Output Voltage: 3.3, 5, 12, 15, ±5, ±12, ±15 VDC
 Output Power: 10W ~ 20W
 Operating Case Temperature: -45°C ~ 115°C
 High Efficiency up to 90%
 Package: Flat & Heat sink embedded
 Size: 1.00" x 1.00" x 0.40" (0.50")
 25.4 x 25.4 x 10.2 (12.7)mm

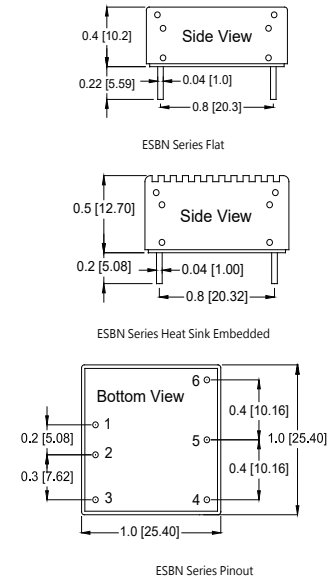

ESCN Series

30W~60W / 2" x 1"

2:1 / 4:1 Wide Input Voltage: 9-36, 18-36, 18-75, 36-75, 40-160 VDC
 Output Voltage: 3.3, 5, 12, 15, 24, ±12, ±15, ±24 VDC
 Output Power: 30W ~ 60W
 Operating Case Temperature: -45°C ~ 115°C
 High Efficiency up to 90%
 Package: Flat & 6-sided metal case is optional
 Size: 2.00" x 1.00" x 0.40"
 50.8 x 25.4 x 10.2mm

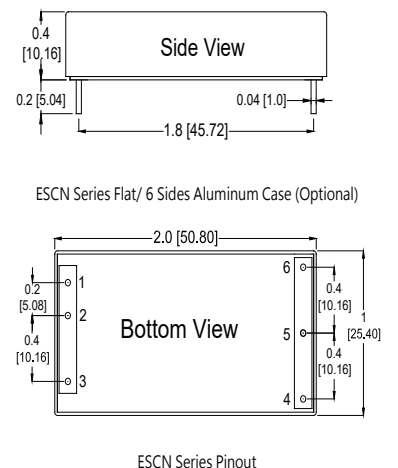

DC/DC Industry Application Product Introduction

DC/DC Encapsulated - S Product Feature

- Single / Dual Outputs
- Built in EMI filter meets EN55032 Class A without external components (Depends on different model)
- Isolation voltage up to 2000 VDC
- No life-span constrained Ceramic Capacitor inside

- Industrial standard pins, metal shell design, easy to heat dissipation and EMI
- Fully SMT manufacturing, standard product, with good lead time, cost-effective
- Provide remote control of output voltage
- Output voltage trim range of -10%, +10%
- Fully protected: OCP / OVP / OTP / UVLO

ESAS Series

15W / DIP24、SMD24

4:1 Wide Input Voltage:

9-36, 18-75, 40-160 VDC

Output Voltage:

5, 12, 15, ±12, ±15 VDC

Output Power:15W

Operating Case Temperature:

-40°C ~ 100°C

High Efficiency up to 88%

Package: Metal Case &

Plastic Case

Size: 1.27" x 0.65" x 0.40"

32.3 x 16.5 x 10.2mm

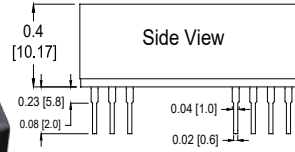
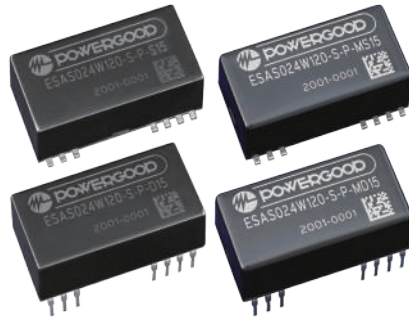

ESAS Series DIP24 Metal Case / Plastic Case

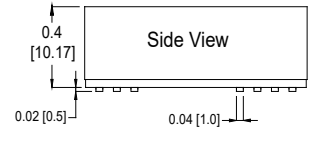

ESAS Series SMD24 Metal Case / Plastic Case

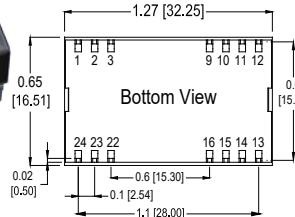

ESAS Series DIP24 Pinout

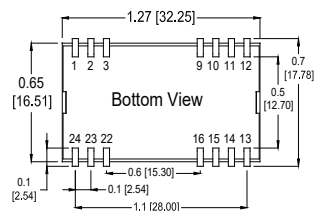

ESAS Series SMD 24 Pinout

ESBS Series

30W / 1" x 1"

4:1 Wide Input Voltage:

9-36, 18-75, 40-160 VDC

Output Voltage:

5, 12, 15, ±12, ±15 VDC

Output Power:30W

Operating Case Temperature:

-40°C ~ 100°C

High Efficiency up to 88%

Package: Flat

Size: 1.00" x 1.00" x 0.40"

25.4 x 25.4 x 10.2mm

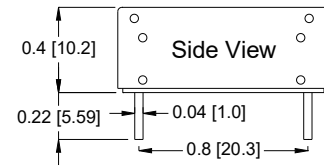

ESBS Series Flat

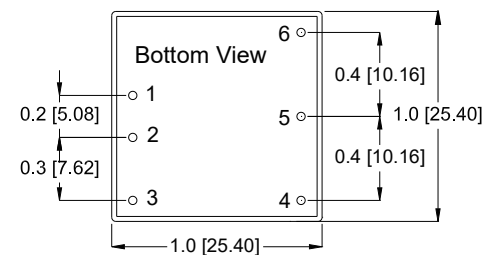

ESBS Series Pinout

ESCS Series

50W / 2" x 1"

4:1 Wide Input Voltage:

9-36, 18-75, 40-180 VDC

Output Voltage:

5, 12, 15, ±12, ±15 VDC

Output Power:50W

Operating Case Temperature:

-40°C ~ 100°C

High Efficiency up to 89%

Package: Flat

Size: 2.00" x 1.00" x 0.40"

50.8 x 25.4 x 10.2mm

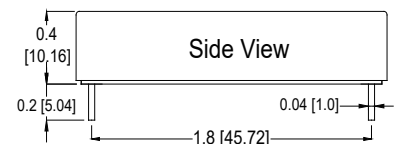

ESCS Series Flat

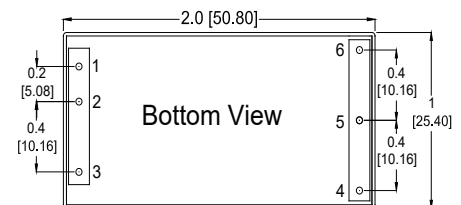

ESCS Series Pinout

DC/DC Industry Application Product Introduction

DC/DC Brick Series – B Product Feature

- 2:1 / 4:1 / 8:1 / 12:1 Ultra-wide input voltage
- Single / Dual / Multi Outputs
- Built-in EMI filter
- Wide operating temperature -45°C ~ +105°C (Optional: -55°C ~ +125°C)
- Isolation voltage up to 2250 VDC
- No life-span constrained Ceramic Capacitor inside
- Provide remote control of output voltage
- Fully protected: OCP / OVP / OTP / UVLO
- The DOSA and VICOR pins are optional and can replace directly without any other additional components.
- Output voltage trim range of -10%, +10%
- Input voltage range up to 110 (40-180) Vin (continuous), with stronger anti input surge ability and higher reliability.

MQB Series

50W, 75W / 1/4 Brick-DOSA pinout
Ultra-Wide Input · Multi Output
8:1 / 12:1 Ultra-Wide Input Voltage:

9-75, 14-154 VDC

Output Voltage:

5, 12, 15, 24, ±12, ±15, ±24 VDC

Output Power: 50W · 75W

Operating Case Temperature:

-45°C ~ 105°C

High Efficiency up to 90%

Package: Flat

Size: 2.36" x 1.57" x 0.49"

60.0 x 40.0 x 12.4mm

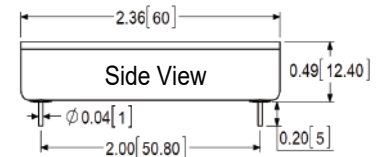

MQB Series Flat

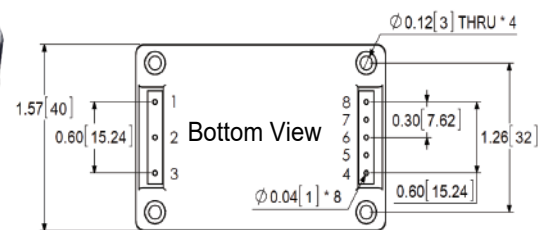

MQB Series DOSA Pinout

STB Series

50W / 1/16 Brick with-DOSA pinout

2:1 / 4:1 Wide Input Voltage:

9-36, 18-36, 18-75, 36-75 VDC

Output Voltage: 3.3, 5, 12, 15, 24 VDC

Output Power: 50W

Operating Case Temperature:

-45°C ~ 105°C

High Efficiency up to 91%

Package: 6 sides aluminum case with flange & Flat

Size: 1.49" x 1.46" x 0.52"

37.8 x 37.2 x 13.2mm (With Flange)

Size: 1.48" x 1.08" x 0.52"

37.5 x 27.4 x 13.2mm (Flat)

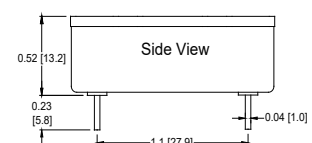

STB Series 6 sides aluminum case with flange / Flat

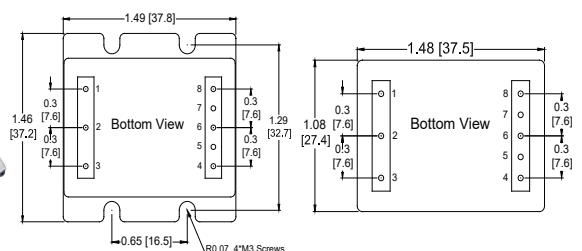

STB Series 6 sides aluminum case with flange
DOSA Pinout

STB Series Flat DOSA Pinout

DC/DC Industry Application Product Introduction

DC/DC Brick Series – B Product Feature

SQB Series

150W / 1/8 Brick、1/4 Brick
with DOSA、VICOR pinout
2:1 / 4:1 Wide Input Voltage:
9-36, 18-36, 18-75, 40-180,
180-425 VDC
Output Voltage: 5, 12, 24, 28, 48 VDC
Output Power: 150W
Operating Case Temperature:
-45°C ~ 105°C
High Efficiency up to 92%
Package: 1/8 Brick Flat
1/4 Brick with flange
Size:
1/8 Brick- 2.38" x 1.08" x 0.56"
60.4 x 27.4 x 14.2 mm
1/4 Brick- 2.38" x 1.47" x 0.56"
60.4 x 37.3 x 14.2 mm



1/8 Brick & 1/4 Brick DOSA & Vicor Pinout

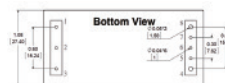

1/8 Brick DOSA Pinout/ 6-sided metal case



1/8 Brick VICOR Pinout/ 6-sided metal case

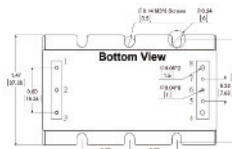

1/4 Brick DOSA Pinout/ 6-sided metal case

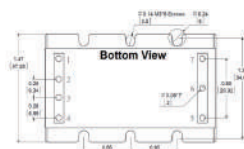

1/4 Brick VICOR Pinout/ 6-sided metal case

SHB Series

200W~300W / 1/2 Brick
with DOSA、VICOR pinout
2:1 / 4:1 Wide Input Voltage:
9-36, 18-36, 18-75, 40-180,
180-425 VDC
Output Voltage: 5, 12, 24, 28, 48 VDC
Output Power: 200W ~ 300W
Operating Case Temperature:
-45°C ~ 105°C
High Efficiency up to 90%
Package: 6 sides aluminum case
with flange
Size: 2.42" x 2.40" x 0.59"
61.4 x 61.0 x 15.0 mm

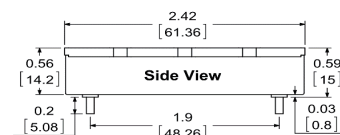

1/2 Brick DOSA & Vicor Pinout

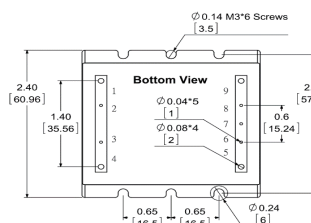

1/2 Brick DOSA Pinout/ 6-sided metal case

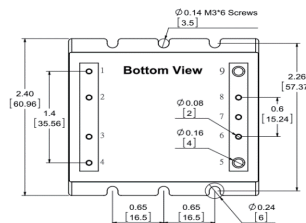

1/2 Brick VICOR Pinout/ 6-sided metal case

SFB Series

400W~600W / Full Brick
with VICOR pinout
2:1 / 4:1 Wide Input Voltage:
9-36, 18-36, 18-75, 40-180,
180-425 VDC
Output Voltage: 12, 24, 28, 48 VDC
Output Power: 400W ~ 600W
Operating Case Temperature:
-45°C ~ 105°C
High Efficiency up to 89%
Package: 6 sides aluminum case
with flange
Provide parallel function
Size: 4.62" x 2.40" x 0.59"
117.3 x 61.0 x 15.0mm

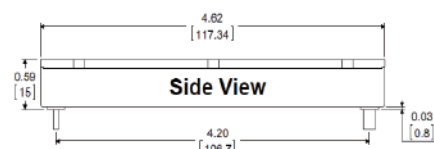

Full Brick Vicor Pinout

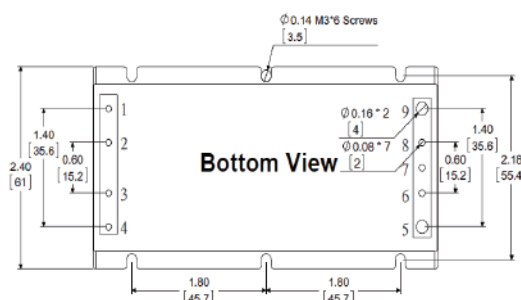

Full Brick Vicor Pinout/ 6-sided metal case

DC/DC Industry Application Product Introduction

DC/DC Brick Series - S Product Feature

- Built-in EMI filter
- Isolation voltage up to 2250 VDC
- No life-span constrained Ceramic Capacitor inside
- Fully SMT manufacturing, Standard product, with good lead time, cost-effective
- Output voltage trim range of -10%, +10%
- Fully protected: OCP / OVP / OTP / UVLO
- The DOSA and VICOR pins are optional, can replace directly without any other additional components.
- Input voltage range up to 110 (40-180) Vin (continuous), with stronger anti input surge ability and higher reliability. Input voltage range up to 300 (180-425) Vin, can be compatible with major brands input voltage range.

SQBS Series

50W~100W / 1/8 Brick、1/4 Brick with DOSA、VICOR pinout

2:1 / 4:1 Wide Input Voltage:

9-36, 18-75, 40-180, 180-425 VDC

Output Voltage: 5, 12, 24, 28, 48 VDC

Output Power: 50~100W

Operating Case Temperature:

-40°C ~ 100°C

High Efficiency up to 89%

Package: 1/8 Brick Flat

1/4 Brick with flange

Size:

1/8 Brick- 2.38" x 1.08" x 0.56"

60.4 x 27.4 x 14.2 mm

1/4 Brick- 2.38" x 1.47" x 0.56"

60.4 x 37.3 x 14.2 mm



1/8 Brick & 1/4 Brick DOSA & Vicor Pinout

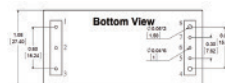

1/8 Brick DOSA Pinout/ 6-sided metal case



1/8 Brick VICOR Pinout/ 6-sided metal case

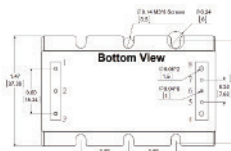

1/4 Brick DOSA Pinout/ 6-sided metal case

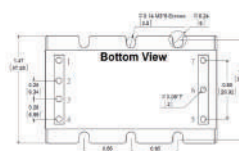

1/4 Brick VICOR Pinout/ 6-sided metal case

SHBS Series

50W~100W / 1/2 Brick

with DOSA、VICOR pinout

2:1 / 4:1 Wide Input Voltage:

9-36, 18-36, 18-75, 40-180,

180-425 VDC

Output Voltage: 5, 12, 24, 28, 48 VDC

Output Power: 50W ~ 100W

Operating Case Temperature:

-40°C ~ 100°C

High Efficiency up to 89%

Package: 6 sides aluminum case with flange

Size: 2.42" x 2.40" x 0.59"

61.4 x 61.0 x 15.0mm

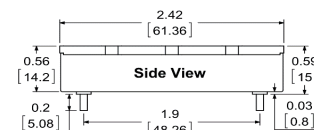

1/2 Brick DOSA & Vicor Pinout

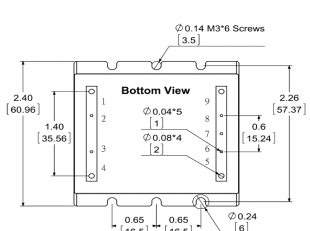

1/2 Brick DOSA Pinout/ 6-sided metal case

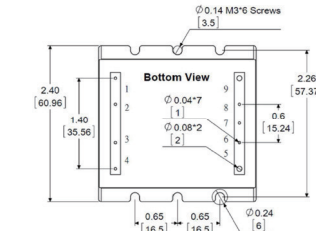

1/2 Brick VICOR Pinout/ 6-sided metal case

SFBS Series

50W~100W / Full Brick

with VICOR pinout

2:1 / 4:1 Wide Input Voltage:

9-36, 18-36, 18-75, 40-180,

180-425 VDC

Output Voltage: 5, 12, 24, 28, 48 VDC

Output Power: 50W ~ 100W

Operating Case Temperature:

-40°C ~ 100°C

High Efficiency up to 89%

Package: 6 sides aluminum case with flange

Size: 4.62" x 2.40" x 0.59"

117.3 x 61.0 x 15.0mm

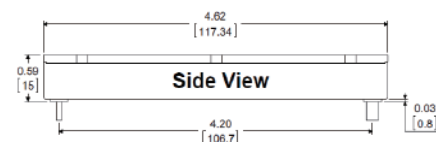

Full Brick Vicor Pinout

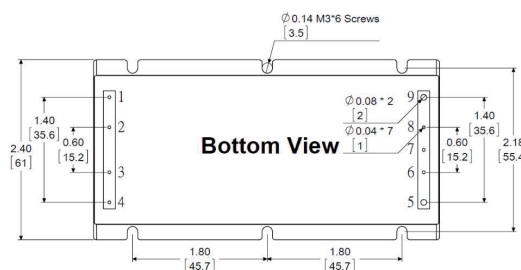

Full Brick Vicor Pinout/ 6-sided metal case



POWERGOOD TECH. RESEARCH CO., LTD

Address : 5F, No.40, Keya Rd., Daya Dist., Taichung City 42881, Taiwan

Website : www.powergood.com

E-mail : sales1@powergood.com

