



SQBS Series

100W / Quarter Brick

DC/DC

Applications

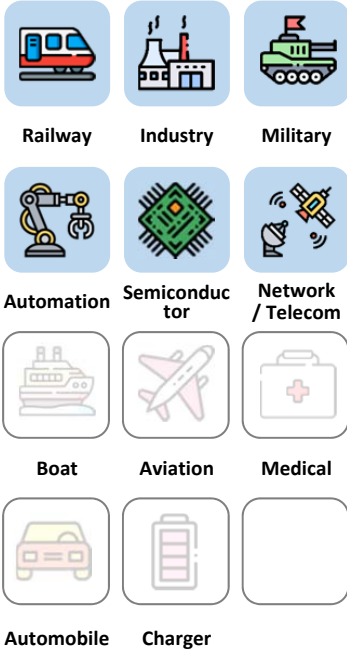

3 Years Warranty



Features

1/4 Brick	4 : 1 Wide input range	DOSA Pin out	Vicor Pin out	PI FILTER Built-in	2250 VDC Insulation	MLCC No life-span constrained	89 % High efficiency
ON / OFF REMOTE	METAL CASE	UVLO	OCP	OVP	OTP		

Model Number Structure

Series Name	Input Voltage (VDC)	Output Voltage (VDC)	Pin out	Remote Control Option	Shape	Watt
Supreme series	024W : 9-36	050 : 5				
Quarter Brick	048W : 18-75	120 : 12	S : Dosa	P : Positive logic	B : Base Plate	50
Second	110 : 40-180	240 : 24	V : Vicor	N : Negative logic	F : No Flange	100
	300 : 180-425	280 : 28				
		480 : 48				

Model Selection Guide

Typical @ Ta=+25 °C under nominal line voltage conditions unless noted

Model	Input			Output			Efficiency
	Voltage (V)		Current (A)	Voltage	Current	Power	
	Range	Nominal	Full load	(V)	(A)	(W)	Typ.(%)
SQBS024W050-□-□-□50	9-36	24	2.37	5	10	50	88
SQBS024W120-□-□-□50	9-36	24	2.34	12	4.17	50	89
SQBS024W240-□-□-□50	9-36	24	2.34	24	2.08	50	89
SQBS024W280-□-□-□50	9-36	24	2.34	28	1.79	50	89
SQBS024W480-□-□-□50	9-36	24	2.34	48	1.04	50	89
SQBS024W050-□-□-□100	9-36	24	4.73	5	20	100	88
SQBS024W120-□-□-□100	9-36	24	4.68	12	8.4	100	89
SQBS024W240-□-□-□100	9-36	24	4.68	24	4.17	100	89
SQBS024W280-□-□-□100	9-36	24	4.68	28	3.57	100	89
SQBS024W480-□-□-□100	9-36	24	4.68	48	2.08	100	89
SQBS048W050-□-□-□50	18-75	48	1.18	5	10	50	88
SQBS048W120-□-□-□50	18-75	48	1.17	12	4.17	50	89
SQBS048W240-□-□-□50	18-75	48	1.17	24	2.08	50	89
SQBS048W280-□-□-□50	18-75	48	1.17	28	1.79	50	89
SQBS048W480-□-□-□50	18-75	48	1.17	48	1.04	50	89
SQBS048W050-□-□-□100	18-75	48	2.37	5	20	100	88
SQBS048W120-□-□-□100	18-75	48	2.34	12	8.4	100	89
SQBS048W240-□-□-□100	18-75	48	2.34	24	4.17	100	89
SQBS048W280-□-□-□100	18-75	48	2.34	28	3.57	100	89
SQBS048W480-□-□-□100	18-75	48	2.34	48	2.08	100	89

Model	Input			Output			Efficiency
	Voltage (V)		Current (A)	Voltage	Current	Power	
	Range	Nominal	Full load	(V)	(A)	(W)	Typ.(%)
SQBS110050-□-□-□50	40-180	110	0.52	5	10	50	88
SQBS110120-□-□-□50	40-180	110	0.51	12	4.17	50	89
SQBS110240-□-□-□50	40-180	110	0.51	24	2.08	50	89
SQBS110280-□-□-□50	40-180	110	0.51	28	1.79	50	89
SQBS110480-□-□-□50	40-180	110	0.51	48	1.04	50	89
SQBS110050-□-□-□100	40-180	110	1.02	5	20	100	88
SQBS110120-□-□-□100	40-180	110	1.02	12	8.4	100	89
SQBS110240-□-□-□100	40-180	110	1.02	24	4.17	100	89
SQBS110280-□-□-□100	40-180	110	1.02	28	3.57	100	89
SQBS110480-□-□-□100	40-180	110	1.02	48	2.08	100	89
SQBS300050-□-□-□50	180-425	300	0.19	5	10	50	88
SQBS300120-□-□-□50	180-425	300	0.19	12	4.17	50	89
SQBS300240-□-□-□50	180-425	300	0.19	24	2.08	50	89
SQBS300280-□-□-□50	180-425	300	0.19	28	1.79	50	89
SQBS300480-□-□-□50	180-425	300	0.19	48	1.04	50	89
SQBS300050-□-□-□100	180-425	300	0.37	5	20	100	88
SQBS300120-□-□-□100	180-425	300	0.37	12	8.4	100	89
SQBS300240-□-□-□100	180-425	300	0.37	24	4.17	100	89
SQBS300280-□-□-□100	180-425	300	0.37	28	3.57	100	89
SQBS300480-□-□-□100	180-425	300	0.37	48	2.08	100	89

Description

Supreme series - Quarter Brick - Second generation converter is composed of Isolated, board-mountable, fixed switching frequency DC-DC converters that use synchronous rectification to achieve extremely high power conversion efficiency. These DC-DC converter modules use advanced power processing, control and packaging technologies to enhance the performance, flexibility, reliability and cost effectiveness of mature power components. Each module is six-sided metal case enclosed to provide protection from the harsh environments seen in many industrial and transportation applications.

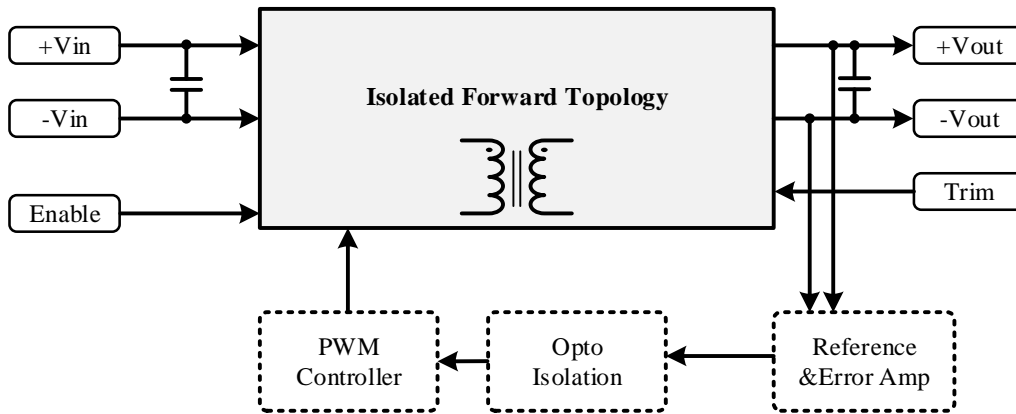

SQBS Series Block Diagram

Electrical Specifications

(Typical @ Ta=+25°C under nominal line voltage conditions unless noted.)

Input Specifications

Parameter	Notes and Conditions	Min.	Typ.	Max.	Unit
Transient Input Voltage Ranges	SQBS024W models(100ms Max)			50	VDC
	SQBS048W models(100ms Max)			80	
	SQBS110 models(100ms Max)			250	
	SQBS300 models(100ms Max)			500	
Operating Input Voltage Ranges	SQBS024W models	9	24	36	VDC
	SQBS048W models	18	48	75	
	SQBS110 models	40	110	180	
	SQBS300 models	180	300	425	
Under-Voltage Lockout Start up Voltage	SQBS024W models			9	VDC
	SQBS048W models			18	
	SQBS110 models			40	
	SQBS300 models			180	
Under-Voltage Lockout Shutdown Voltage	SQBS024W models		8		VDC
	SQBS048W models		17		
	SQBS110 models		38		
	SQBS300 models		145		
Over-Voltage Lockout Turn OFF Threshold	SQBS024W models			50	VDC
	SQBS048W models			80	
	SQBS110 models			180	
	SQBS300 models			450	
Over-Voltage Lockout Turn ON Threshold	SQBS024W models	36			VDC
	SQBS048W models	75			
	SQBS110 models	180			
	SQBS300 models	425			
Input Current	See model selection guide, Standby mode (OFF,UVLO) 5mA				
Enable Function Input	SQBS300 models	Positive logic	ON	Open	
			OFF	Short	
	Others	Negative logic	ON	Short	VDC
			OFF	Open	
	Others	Positive logic	ON	Open or 12 ~ 20	VDC
		OFF	Short or 0 ~ 1.2		
	Others	Negative logic	ON	Short or 0 ~ 1.2	VDC
		OFF	Open or 12 ~ 20		

Output Specifications

Parameter	Notes and Conditions	Min.	Typ.	Max.	Unit
Output Voltage Accuracy	V _{NOM} 50% Load			±1.5	%
Line Regulation	Low Line to High Line			±0.3	%
Load Regulation	10% to 100% Load			±0.5	%
Output Ripple & Noise Voltage	Bandwidth 20MHz and with 1uF MLCC Output Capacitor		1.5		%V _{pk-pk}
Temperature Coefficient				±0.04	% / °C
Transient Recovery Time	25% load step change		800		µSec.
Transient Peak Deviation	ΔI _o /Δt=2.5A/µs		±2		%V _o
Start-Up Time	When use Enable Function		20		mSec.
Trimming Output Voltage	V _{NOM} 10% Load		±10		%
Over Voltage Protection	V _{NOM} 10% Load		120		%
Output Power Protection	V _{NOM}		120		%

General Specifications & Environmental Specifications

Parameter	Notes and Conditions	Min.	Typ.	Max.	Unit
Switching Frequency	V _{NOM}		220		KHz
Storage Temperature Range	All models	-60		125	°C
Operating Case Temperature	All models	-40		100	°C
Over temperature Protection	All models, Auto. Recovery		105		
Isolation Voltage Input to Output	All models, 1 Minute	2250			VDC
Isolation Resistance Input to Output	All models, 500VDC, At 70%RH	100			MΩ
Isolation Capacitance Input to Output	All models		1500		pF
Humidity (non condensing)	All models			95	%
Calculated MTBF	BellCore-TR-332@ 50°C G.B		1.2		M HR
Thermal shock	Environmental Engineering Experimental Tests	MIL-STD-810F			
Vibration		MIL-STD-810F			
Drop		MIL-STD-810F			
Weight	Shape-B (Base Plate) Shape-F (No Flange Base Plate)		59 56		g (oz.)
Dimensions	Shape-B (Base Plate) Shape-F (No Flange Base Plate)	1.47" x 2.38" x 0.56" (37.3 x 60.4 x 14.2mm) 1.08" x 2.38" x 0.56" (27.4 x 60.4 x 14.2mm)			
Case Material	Aluminum				
Potting Material	Silicone				

Standards Compliance

Parameter	Standard	Test Conditions	Performance Criteria
Environmental Compliance	Reach; RoHS		PASS
EMI	EN55022		Class A / Class B
ESD	EN61000-4-2	±4 kV Air Discharge ±4 kV Contact Discharge	Crit. A
Radiated Immunity	EN61000-4-3	Level 2, 3 V/m	Crit. A
Fast Transient	EN61000-4-4	±2 kV Applied	Crit. A
Surge	EN61000-4-5	±2 kV Applied	Crit. A
Conducted Immunity	EN61000-4-6	Level 2, 3 V rms	Crit. A

It is recommended to protect the input by fuses or other protection devices.

Modules could meet EN55022 Class A and Class B standard with external components.

The information and specifications contained in this data sheet are believed to be correct at time of publication. All specifications are subject to change without notice. No rights under any patent accompany the sale of any such products or information contained herein.

Conducted EMI

Input terminal value (typ.) SQBS024W120-V-P-B150 @Vin = 18VDC, Iout = 12.5A

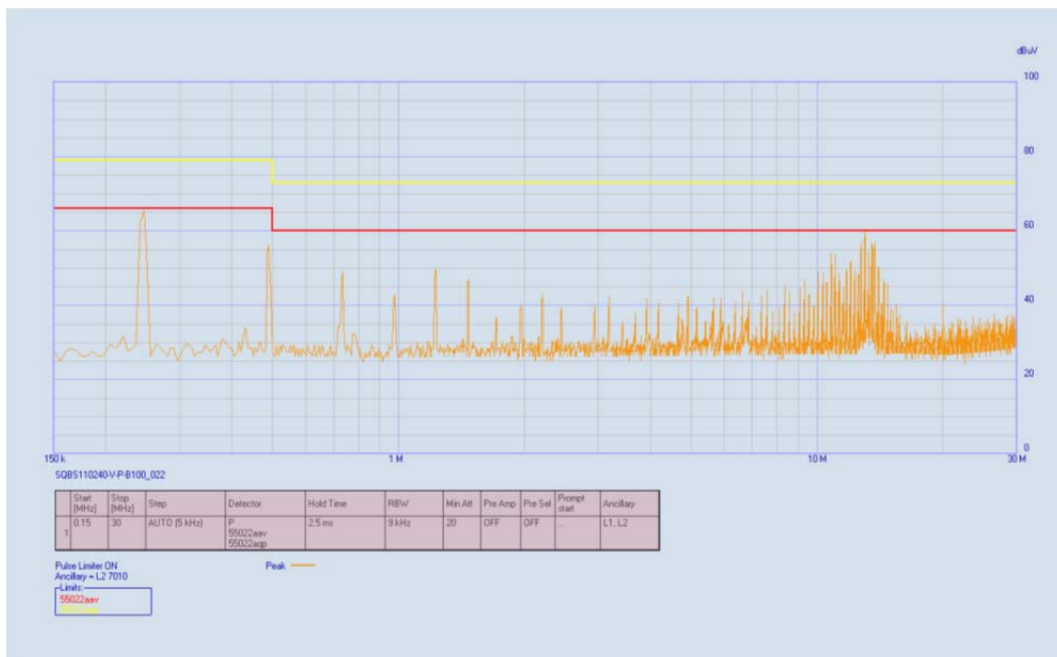

The fundamental switching frequency of the module is 260 kHz.

Characteristic Curves

Testing conditions are at typical input, $T_a=+25^{\circ}\text{C}$, full load (horizontal mount) Unless otherwise indicated

The figures of SQBS024W240-V-P-B100

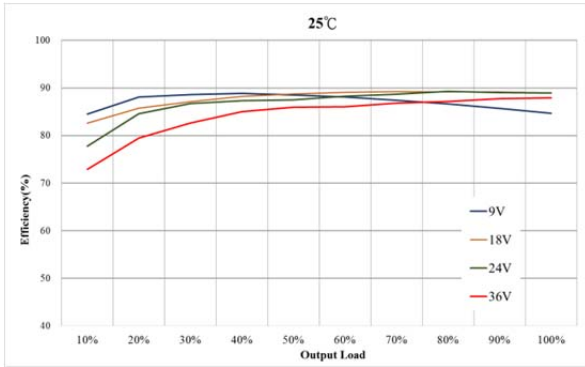

Figure 1 : Efficiency at Minimum, Nominal and Maximum Input Voltages VS. Output Load.

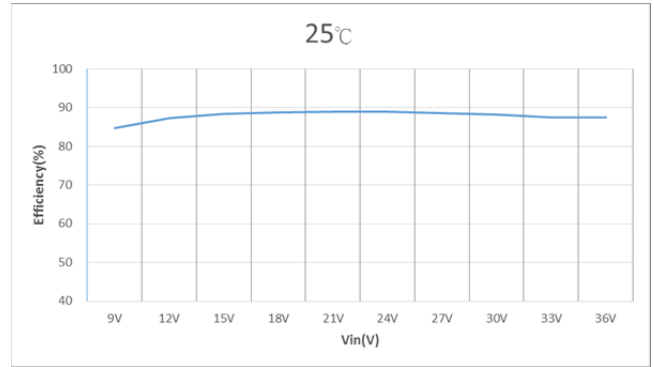

Figure 2 : Efficiency VS. Input Voltages at 100% rated power

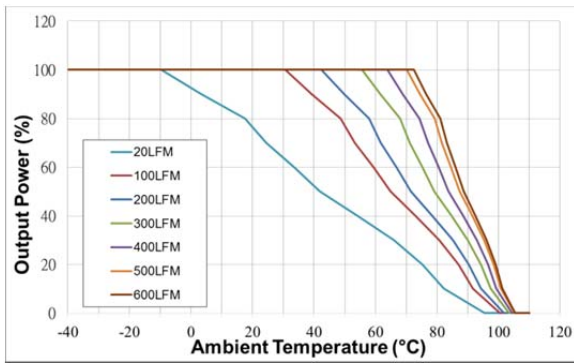

Figure 3 : Ambient Temperature VS. Output Power Derating Curves

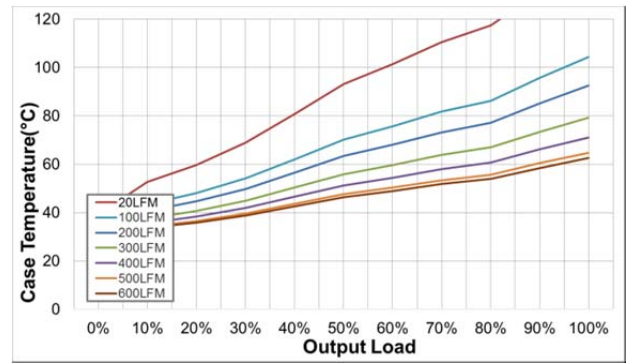

Figure 4 : Case Temperature VS. Output rated Power

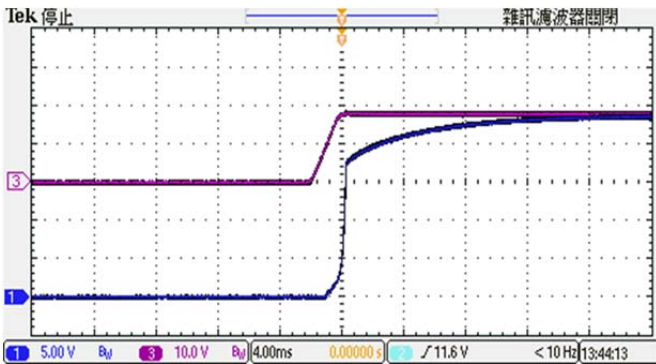

Figure 5 : CH1 = Vout, CH3 = Nominal Input
Typical Start-up waveform at Full load.

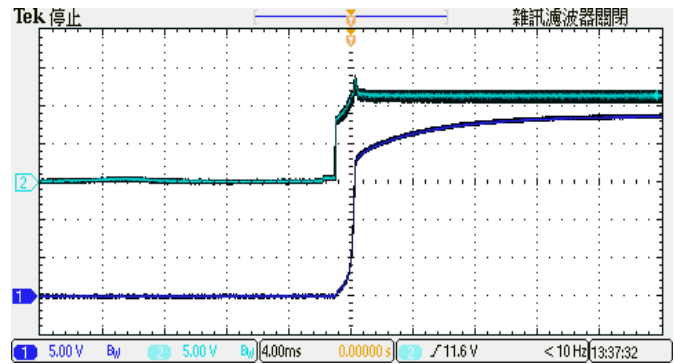

Figure 6 : CH1 = Vout, CH3 = Enable Pin
Typical Start-up waveform. Input voltage pre-applied

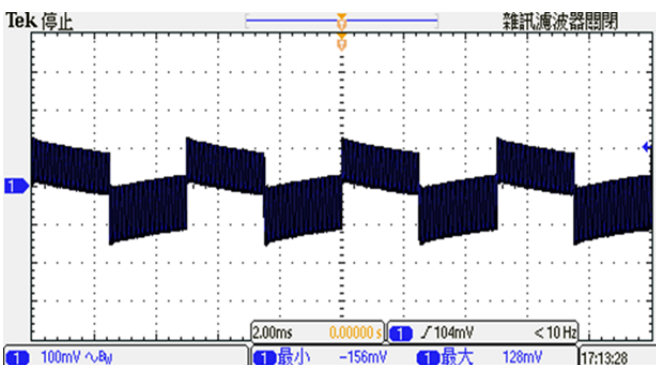

Figure 7 : Transient Response at Output step load
(V_{in} : Typical ,50~75% of output current; $\Delta I_o/\Delta t = 1\text{A}/\mu\text{S}$)

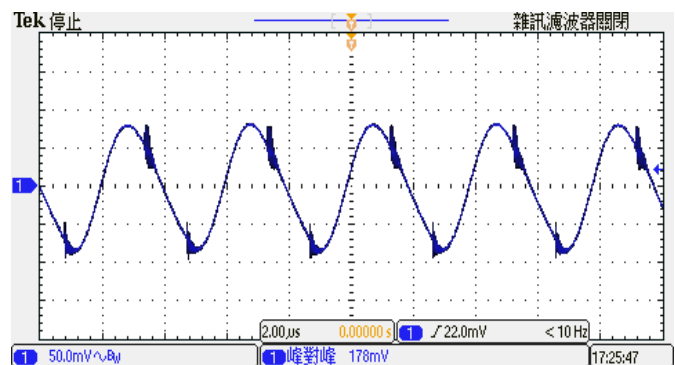
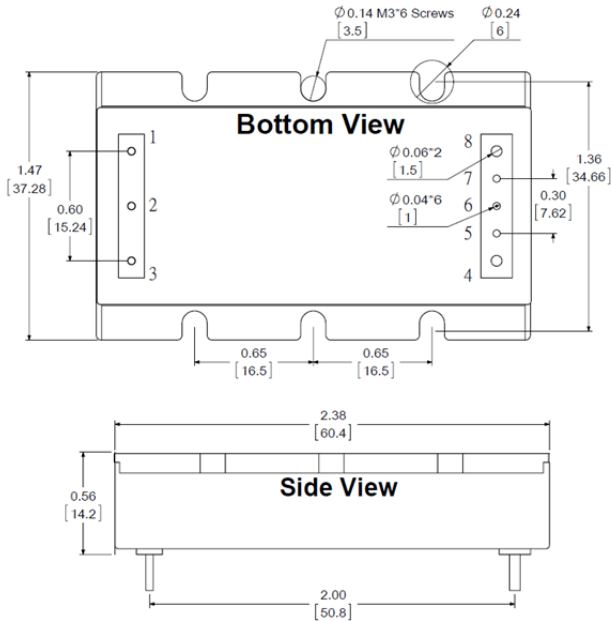

Figure 8 : Output Voltage Ripple & Noise at full load.
(V_{in} : Typical, With Output Capacitor to add 1uF MLCC)

Mechanical Dimensions & Pin Assignments

Shape – B (Base Plate with DOSA pinout)



Shape – F (No Flange Base Plate with DOSA pinout)

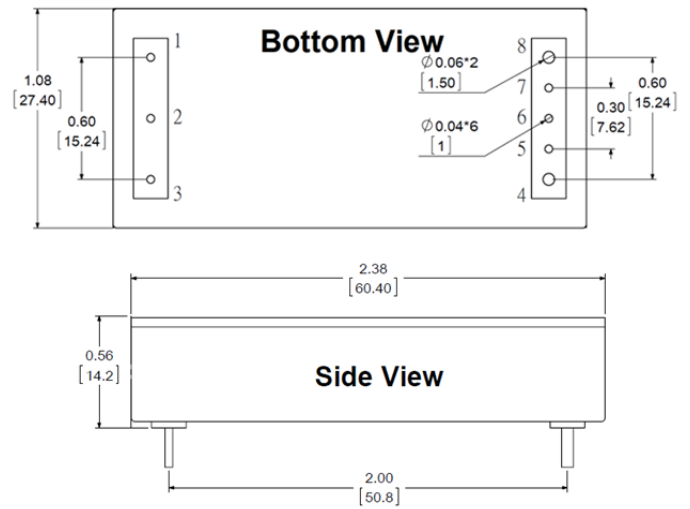

Shape – B (Base Plate with Vicor pinout)

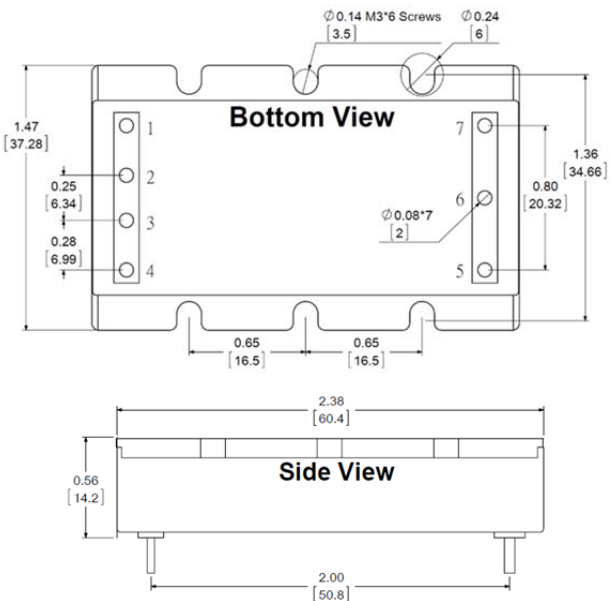

Shape – F (No Flange Base Plate with Vicor pinout)

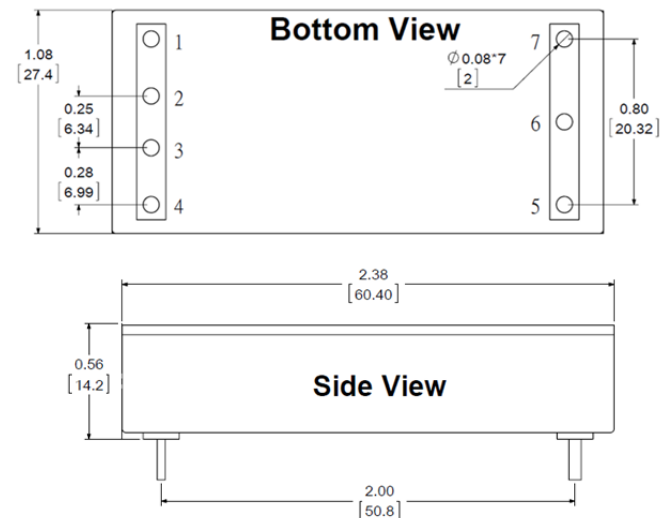

Pin Assignments:

Pin#	Dosa	Vicor
1	-Vin	-Vin
2	Enable	NC
3	+Vin	Enable
4	+Vout	+Vin
5	+Sense	+Vout
6	Trim	Trim
7	-Sense	-Vout
8	-Vout	

Note:

Pin Material: Copper Alloy

Pin Plating: Gold

Dimensions in inches [mm]

Tolerances: .XX±0.02 [.X±0.5mm]

Trimming Output Voltage – for Single output models

Only the single output converters have a trim function. That allows users to adjust the output voltage from +10% to -10%, please refer to the trim table that follow for details. Adjustments to the output voltage can be used with a simple fixed resistor as shown in Figures 1 and 2. A single fixed resistor can increase or decrease the output voltage depending on its connection.

Note:

- ※ Trim adjustments higher than the specified range can have an adverse effect on the converter’s performance and are not recommended.
- ※ If the trim function is not used, leave the trim pin open.

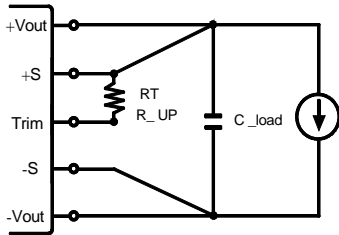

Figure 1. Trim Connections To increase Output Voltages Using Fixed Resistors

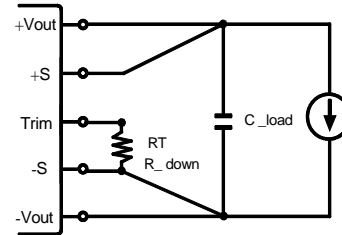

Figure 2. Trim Connections To Decrease Output Voltages Using Fixed Resistors

Vout	Trim up resistor value(KΩ)									
	1%	2%	3%	4%	5%	6%	7%	8%	9%	10%
5	109	50	30	20	14	10	7	5	3.3	2
12	258	115	67	44	29	20	13	7.8	3.8	0.6
24	514	232	137	90	62	43	30	20	12	5.5
28	602	271	161	105	72	50	34	22	13	5.9
48	1039	464	273	177	120	81	54	34	18	5

Vout	Trim down resistor value(KΩ)									
	-1%	-2%	-3%	-4%	-5%	-6%	-7%	-8%	-9%	-10%
5	137	62	37	25	17	12	9	6	4	2.2
12	358	162	96	63	44	31	21	14	8.9	4.5
24	769	352	213	143	102	74	54	39	28	18
28	860	392	236	158	111	80	57	41	28	17
48	1413	638	380	251	173	121	85	57	35	18

Enable Control Function

The primary-side, Enable Control function can be specified to operate with either positive or negative polarity. Positive-polarity devices are enabled when the enable pin is left open or is pulled high. See “Enable Function Input.” Positive-polarity devices are disabled when the enable pin is pulled low (under +1.0V with respect to -input). Negative-polarity devices are off when the enable pin is high/open and on when the enable pin is pulled low. See Figure 3.

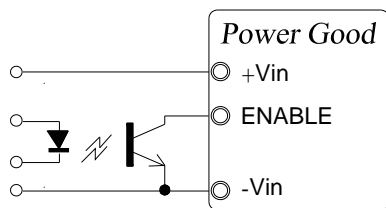

Figure 3. Driving the Enable Control pin

Output Ripple Noise

The two copper strips simulate real-world PCB impedances between the converter and its load. Scope measurements should be made using BNC connectors or The probe ground should be less than 1/2 inch and soldered directly to the fixture. All external capacitors should have appropriate voltage ratings and be located as close to the converter as possible. Temperature variations for all relevant parameters should be taken into consideration. The most effective combination of external I/O capacitors will be a function of line voltage and source impedance, as well as particular load and layout conditions. See Figure 4.

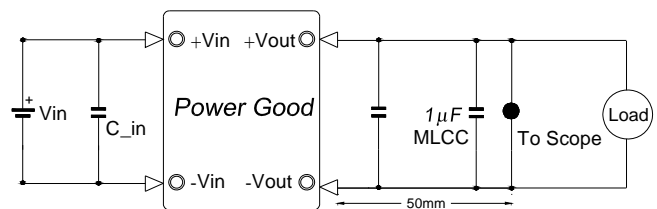

Figure 4. Measuring Output Ripple/Noise(20MHz bandwidth)

