

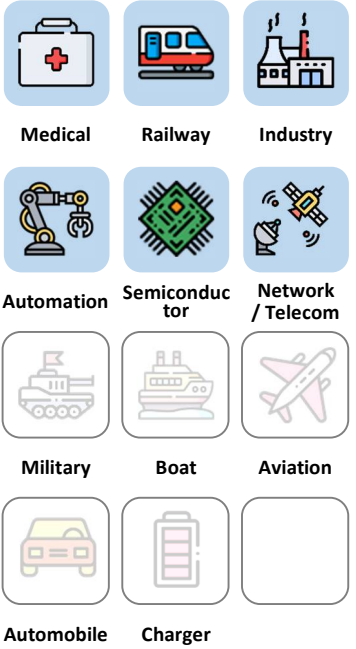

ACH250 Series

250W & 350W / Half Brick AC/DC

Applications



3 Years Warranty



Features

1/2 Brick	90~264VAC Input range	350W Active PFC	Long Hold-up Time	-40~100°C Case Temperature	±5% Output Trimming	3000 VAC Insulation	91 % High efficiency
Base plate cooled	ON / OFF REMOTE (optional)	OCP	OVP	OTP	SCP		

Model Number Structure

AC H 250 - 120 S - 350

Series Name	Package	Watt	Output Voltage (VDC)	Output Quantity	Actual Watt
AC series	Half Brick	250	120 : 12	S : Single	Actual Watt
			190 : 19		
			240 : 24		
			280 : 28		
			360 : 36		
			480 : 48		

Model Selection Guide

Typical @ Ta=+25 °C under nominal line voltage conditions unless noted

Model	Input			Output			Efficiency
	Voltage (V)		Current (A)	Voltage	Current	Power	
	Range	Nominal	Full load	(V)	(A)	(W)	Typ.(%)
ACH250-120S-250	90-264	230	1.21	12	20.80	250	90
ACH250-190S-250	90-264	230	1.19	19	13.16	250	91
ACH250-240S-250	90-264	230	1.19	24	10.4	250	91
ACH250-280S-250	90-264	230	1.19	28	8.93	250	91
ACH250-360S-250	90-264	230	1.21	36	6.94	250	90
ACH250-480S-250	90-264	230	1.21	48	5.20	250	90
ACH250-120S-350	90-264	230	1.69	12	29.17	350	90
ACH250-240S-350	90-264	230	1.67	24	14.58	350	91
ACH250-280S-350	90-264	230	1.67	28	12.5	350	91
ACH250-360S-350	90-264	230	1.69	36	9.72	350	90
ACH250-480S-350	90-264	230	1.69	48	7.29	350	90

Description

AC series - Half Brick 250 converter is a 250W / 350W isolated, regulated ac/dc converter with active PFC in half brick package and long hold-up time setting by external capacitors. It features a high efficiency up to 91%, wide working case temperature range -40~+100°C, no minimum load required, 3kVac reinforced insulation, OVP, OCP, SCP, OTP, etc. These power modules use advanced power processing, control and packaging technologies and are suitable for many applications with harsh environments where wide temperature variation and space limitations, etc.

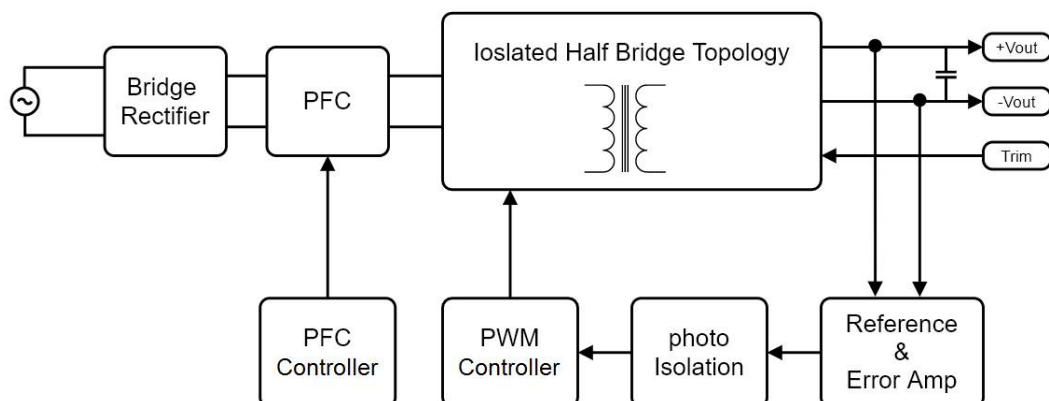

ACH250 Series Block Diagram

Electrical Specifications

(Typical @ Ta=+25°C under nominal line voltage conditions unless noted.)

Input Specifications

Parameter	Notes and Conditions	Min.	Typ.	Max.	Unit
Operating Input Voltage Ranges		90	230	264	VAC
Operating Input Frequency Ranges		47	50/60	63	Hz
Input Current	at 115VAC 100% load at 230VAC 100% load		2.6 1.3		A
Inrush Current	cold start at 230Vac, 25°C	Limited by external components (Thermistor)			
Power Factor	at 115VAC 100% load at 230VAC 100% load		1 0.99		
Leakage Current	at 240VAC 60Hz 100% load			0.75	mA

Output Specifications

Parameter	Notes and Conditions	Min.	Typ.	Max.	Unit
Output Voltage Accuracy	100% Load			±1.5	%
Line Regulation	High Line to Low Line			±0.5	%
Load Regulation	0% to 100% Load			±1	%
Output Ripple & Noise Voltage	Bandwidth 20MHz and with 10uF MLCC Output Capacitor			2	%V _{pk-pk}
Output Voltage Adjustment Range	adjustable by external resistor			±5	%
Minimum Load		0			A
Hold Up Time	at full load & 115 VAC	Setting by external capacitors between +BC & -BC			
Over Voltage Protection		120		140	%
Over current Protection	Hiccup mode	120		140	%
Short-circuit Protection	Hiccup mode	Auto-Recovery			

General Specifications & Environmental Specifications

Parameter	Notes and Conditions	Min.	Typ.	Max.	Unit
Switching Frequency	PFC/AC-DC		100/130		kHz
Storage Temperature Range	All models	-55		125	°C
Over temperature Protection	Auto Recovery		110		°C
Operating Case Temperature	on aluminum base plate	-40		100	°C
Humidity (non condensing)	All models			95	%
Isolation Voltage	Input to Output		3000		VAC
	Input to Base		1500		VAC
	Output to Base		500		VAC
Calculated MTBF	BellCore-TR-332@ 50°C G.B		1.1		M HR
Weight			120 (4.23)		g (oz.)
Dimensions		2.36" x 2.30" x 0.50" (60.0 x 58.4 x 12.7mm)			
Case Material	Aluminum base with plastic case				

It is recommended to protect the input by fuses or other protection devices.

Modules could meet EN55022 Class A and Class B standard with external components.

The information and specifications contained in this data sheet are believed to be correct at time of publication. All specifications are subject to change without notice. No rights under any patent accompany the sale of any such products or information contained herein.

Mechanical Dimensions & Pin Assignments

Shape

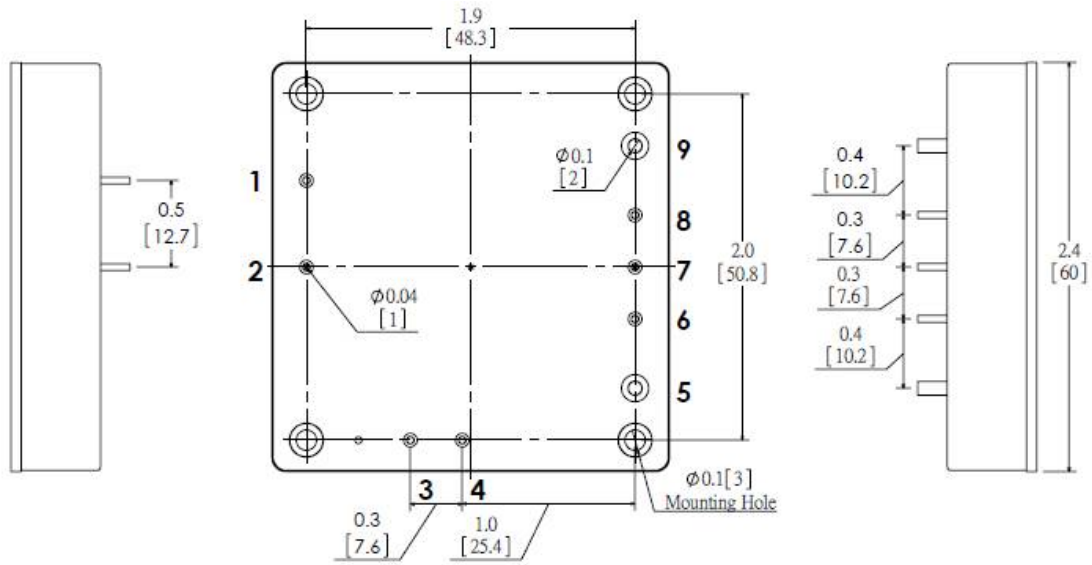

Pin Assignments:

Pin#	Function
1	AC1
2	AC2
3	BC+
4	BC-
5	+Vo
6	+S
7	Trim
8	-S
9	-Vo

Note:

Pin Material: Copper Alloy

Pin Plating: Gold

Dimensions in inches [mm]

Tolerances: .XX±0.25 [.X±0.5mm]

Conducted EMI

Input terminal value (typ.) ACH250-120S-250 @Vin = 230VDC, Iout = 20.83A

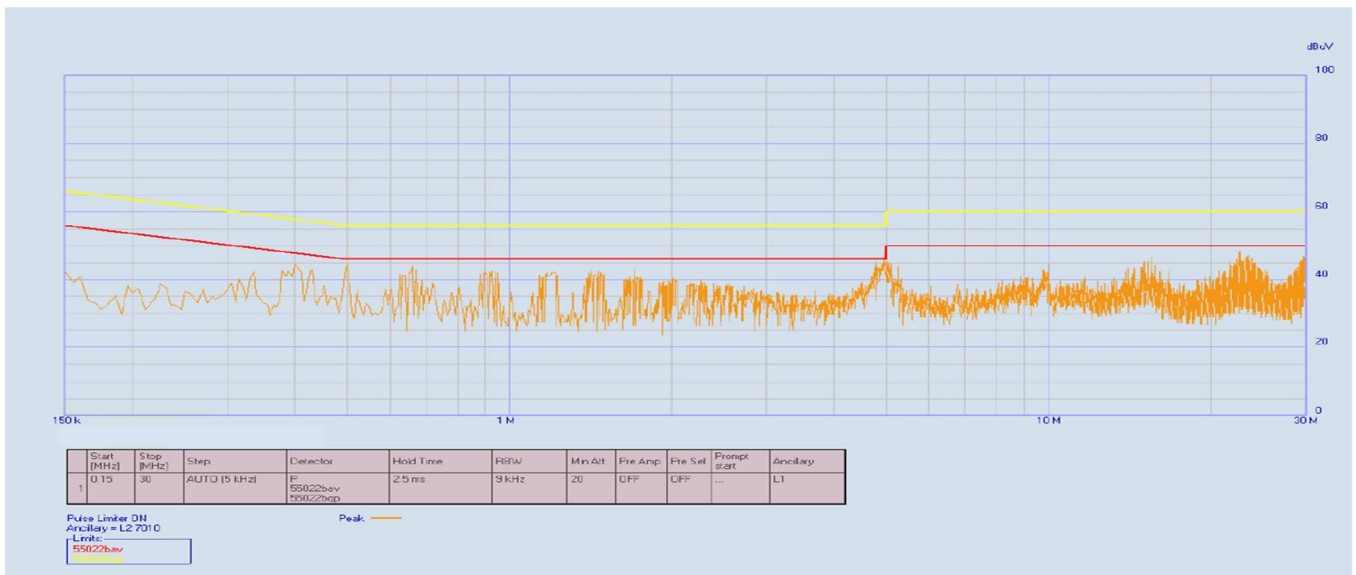

The fundamental switching frequency of the module is 100 kHz.

Characteristic Curves

Testing conditions are at typical input, Ta=+25°C, full load (horizontal mount) Unless otherwise indicated

The figures of ACH250-120S-250

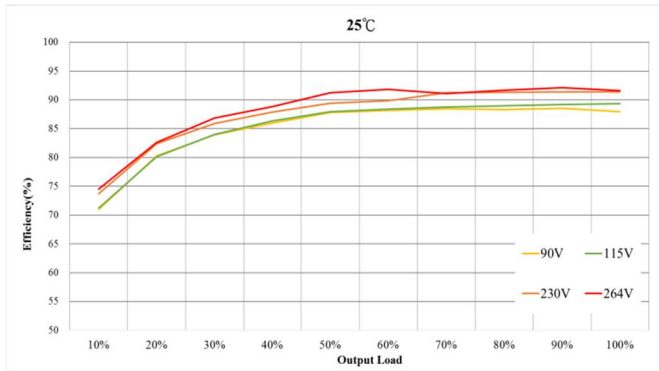

Figure 1 : Efficiency at Minimum, Nominal and Maximum Input Voltages VS. Output Load.

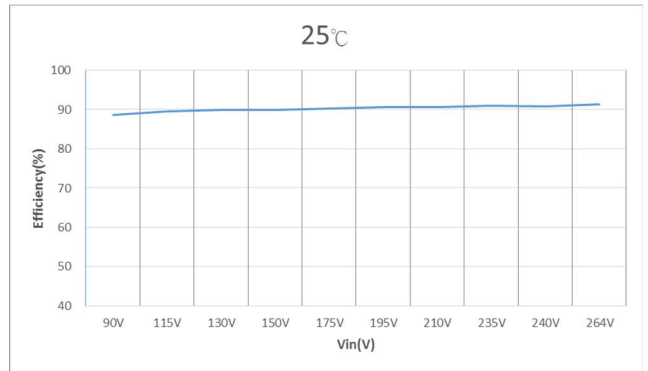

Figure 2 : Efficiency VS. Input Voltages at 100% rated power

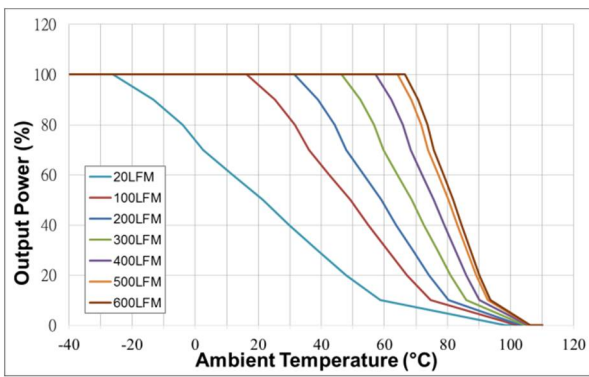

Figure 3 : Ambient Temperature VS. Output Power Derating Curves(Note:20LFM=Free Air)

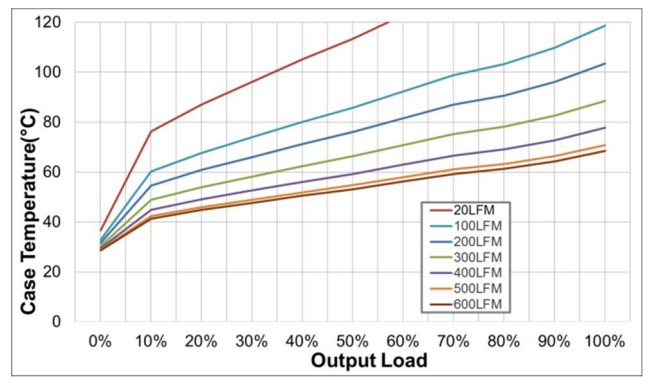

Figure 4 : Case Temperature VS. Output rated Power (Note:20LFM=Free Air)

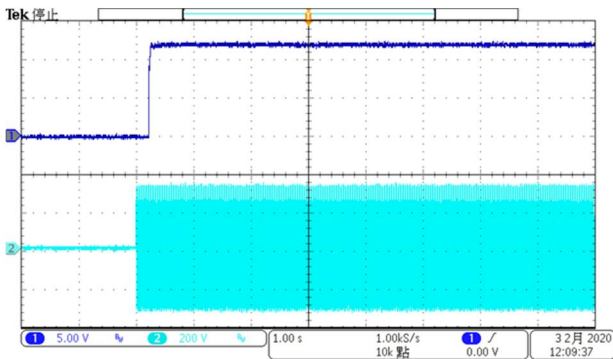

Figure 5 : CH1 = Vout, CH3 = Nominal Input Typical Start-up waveform at Full load.

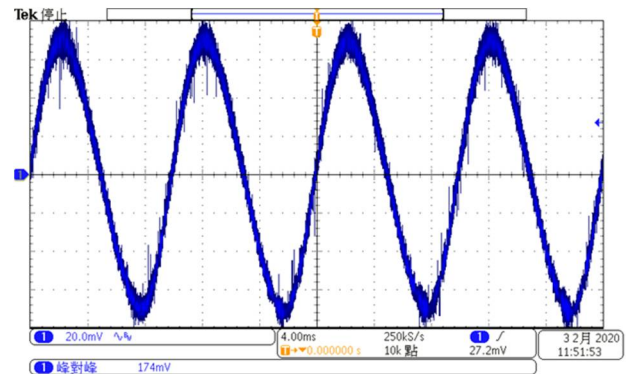

Figure 6 : Output Voltage Ripple & Noise at full load. (Vin: Typical, With Output Capacitor to add 1uF MLCC)

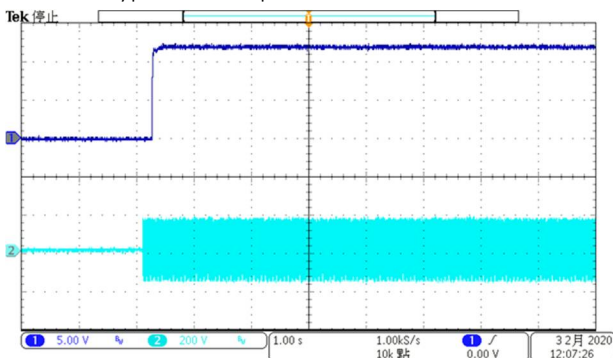

Figure 7 : CH1 = Vout, CH3 = 115V Input Typical Start-up waveform at Full load.

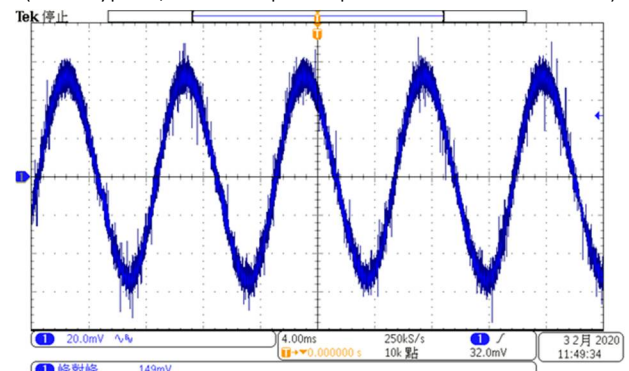

Figure 8 : Output Voltage Ripple & Noise at full load. (Vin: 115V, With Output Capacitor to add 1uF MLCC)

Trimming Output Voltage – for Single output models

Only the single output converters have a trim function. That allows users to adjust the output voltage from +5% to -5%, please refer to the trim table that follow for details. Adjustments to the output voltage can be used with a simple fixed resistor as shown in Figures 1 and 2. A single fixed resistor can increase or decrease the output voltage depending on its connection.

Note:

- ✘ Trim adjustments higher than the specified range can have an adverse effect on the converter’s performance and are not recommended.
- ✘ If the trim function is not used, leave the trim pin open.

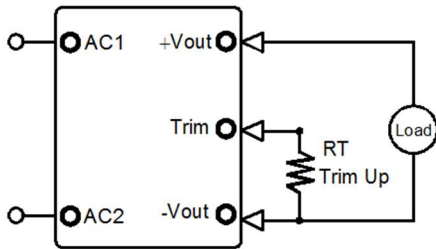

Figure 1. Trim Connections To increase Output Voltages Using Fixed Resistors

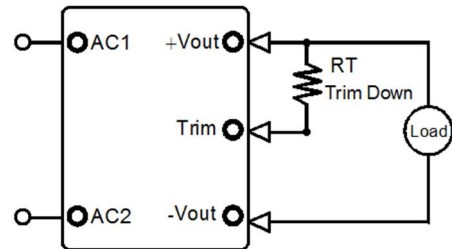

Figure 2. Trim Connections To decrease Output Voltages Using Fixed Resistors

Vout	Trim up resistor value(KΩ)				
	1%	2%	3%	4%	5%
12	198.23	73.56	32.01	11.23	0.00
19	1921.13	745.57	353.71	157.78	0.00
24	228.91	83.45	34.97	10.73	0.00
28	693.51	246.76	97.84	23.38	0.00
36	545.73	197.87	81.91	23.93	0.00
48	1407.66	537.83	247.89	102.91	0.00

Vout	Trim down resistor value(KΩ)				
	-1%	-2%	-3%	-4%	-5%
12	887.57	412.24	253.79	174.57	127.03
19	14840.87	7116.43	4541.62	3254.22	2481.77
24	2419.09	1164.55	746.36	537.27	411.82
28	8806.49	4253.24	2735.50	1976.62	1521.30
36	9054.27	4402.13	2851.42	2076.07	1610.85
48	30796.34	15066.17	9822.78	7201.09	5628.07

Output Ripple Noise

The two copper strips simulate real-world PCB impedances between the converter and its load. Scope measurements should be made using BNC connectors or the probe ground should be less than 1/2 inch and soldered directly to the fixture.

All external capacitors should have appropriate voltage ratings and be located as close to the converter as possible.

Temperature variations for all relevant parameters should be taken into consideration. The most effective combination of external I/O capacitors will be a function of line voltage and source impedance, as well as particular load and layout conditions. See Figure 3.

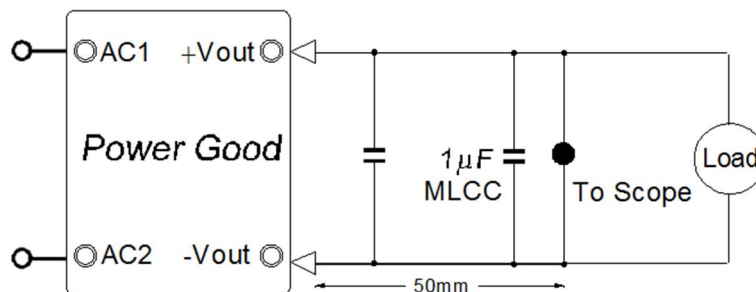
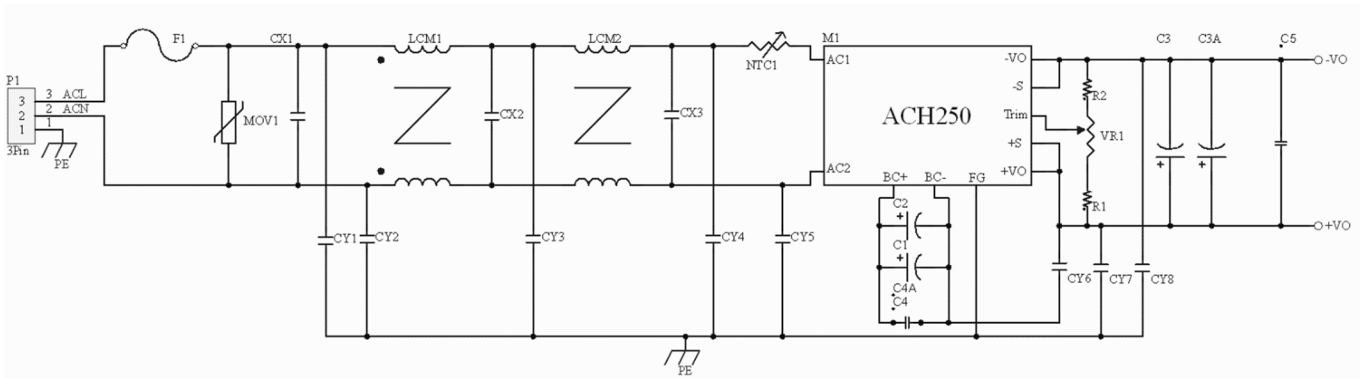

Figure 3. Measuring Output Ripple/Noise (20MHz bandwidth)

Recommended Circuit Diagram



Bill of Materials

No.	Sch Symbol	Description	Rating		Manufacturer / Part Number
1	F1	Fuse	4A/250Vac		Littelfuse 39214000000
2	MOV1	Varistor	620V		Thinking TVR10621K
3	CX1、CX2	X Capacitor	0.47uF/310Vac		EPCOS B32922C3474K
4	CX3	X Capacitor	0.68uF/250Vac		EPCOS B32922C3684K
5	LCM1、LCM2	Common Mode Choke	6.8mH		Amogreentech A121 T14*8*7C with ϕ 0.4mm*25 turns
6	CY2、CY3 CY7、CY6	Y Capacitor	2200pF/250Vac		Murata DE1E3KX222M
7	NTC1	Thermistor	5R		Thinking SCK10053
8	C1、C2	PFC boost capacitor	120uF/420Vdc		NIPPON CHEMI-CON EKXL421ELL121MM30S
9	C3	Output Capacitor	12V	1000uF/35Vdc	UNICON UPL1V102M1021
			19V	1000uF/35Vdc	UNICON UPL1V102M1021
			24V	470uF/50Vdc	UNICON UPL1H471M1021
			28V	470uF/50Vdc	UNICON UPL1H471M1021
			36V	330uF/63Vdc	UNICON UPL1H331M1021
			48V	330uF/63Vdc	UNICON UPL1H331M1021
10	C4	Bypass Capacitor	0.1uF/630Vdc		Murata RDER72J104K4K1H03B
	C5		1uF/100Vdc		Murata GRJ31CR72A105

